

Before you begin

These instructions illustrate the Stylmark[®] Framed Rolling Door for gondola shelves. If you have questions during assembly, call 800-328-2495 to request technical assistance.

Tools you'll need

- #2 Phillips screwdriver
- Level
- Plumb Bob (or long level may be used)
- Tape measure
- 5/16" (.312) hex nut screwdriver
- Carpenter square
- * Drill
- * 1/4" (.250) drill bit

* Needed for shelves without pre-punched holes

Please read these instructions carefully before beginning installation.

ITEM #	DESCRIPTION	QTY
1	TOP TRACK SUB-ASSEMBLY	1
2	BOTTOM TRACK SUB-ASSEMBLY	1
3	SIDE JAMBS	2
4	REAR DOOR WITHOUT LOCK	1
5	FRONT DOOR WITH LOCK (NO LOCK OPTION AVAILABLE)	1
6	BUMPERS	8
7	DRILL SCREW, #8 X 1/2"	4
8	KEPS NUT, #6-32	10
9	MACHINE SCREW, FLAT UNDERCUT 6-32 X 1/2"	10
10	MACHINE SCREW, FLAT UNDERCUT 8-32 X 1/4"	4
11	KEPS NUT, #8-32	4

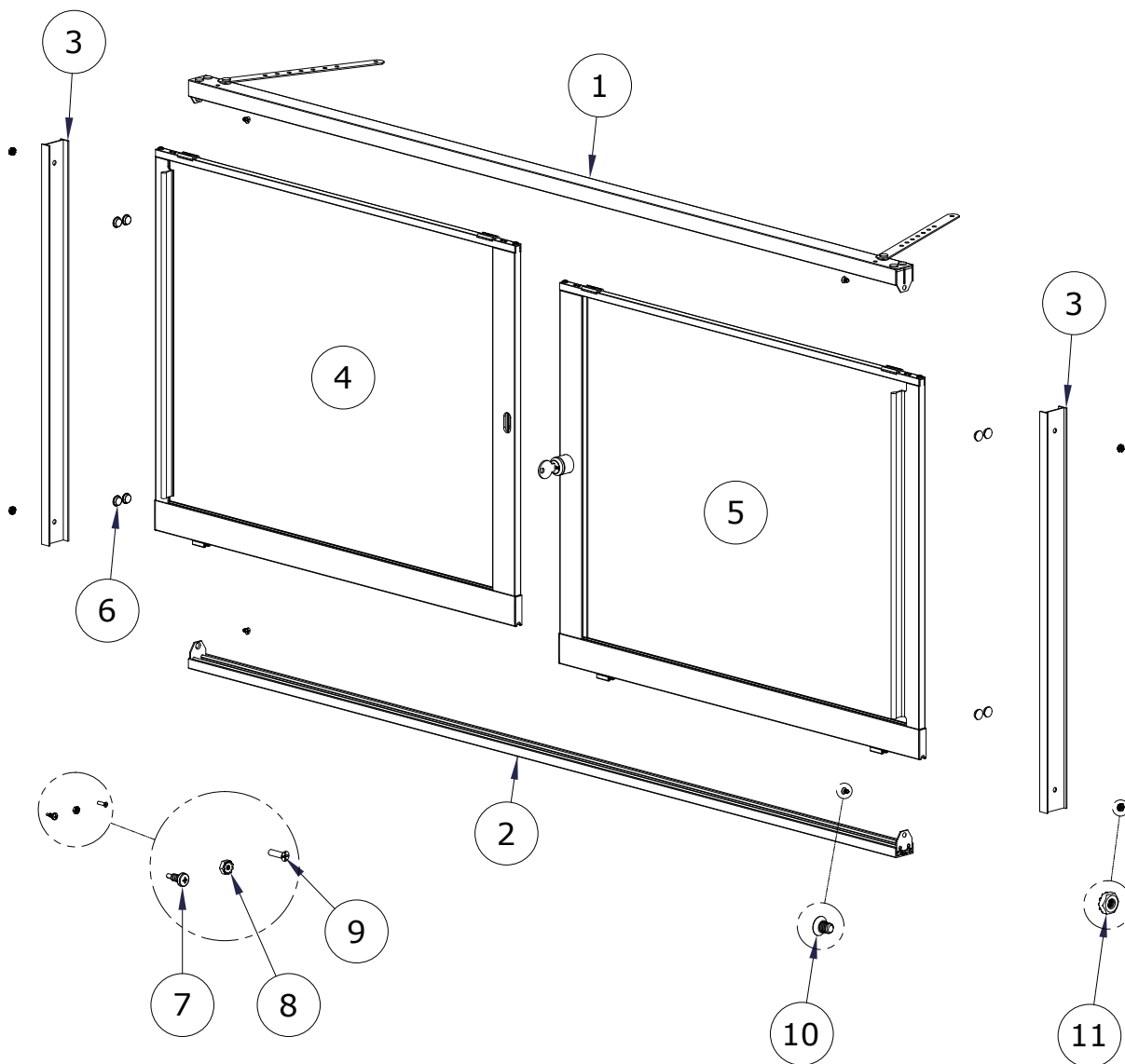

Sheet# 971914
Rev A (1/24)

NOTE:

1. Before you begin, it is important for the fixture and shelves to be leveled precisely. (Reference the fixture providers installation instructions for proper leveling details).
2. All Framed Rolling Doors are provided with hardware specified for frame attachment to standard metal gondola shelving only. (For other installation methods, obtain hardware locally).

Step 1: For proper fit and function, ensure fixture is level, plumb and square per manufacturer's instructions.

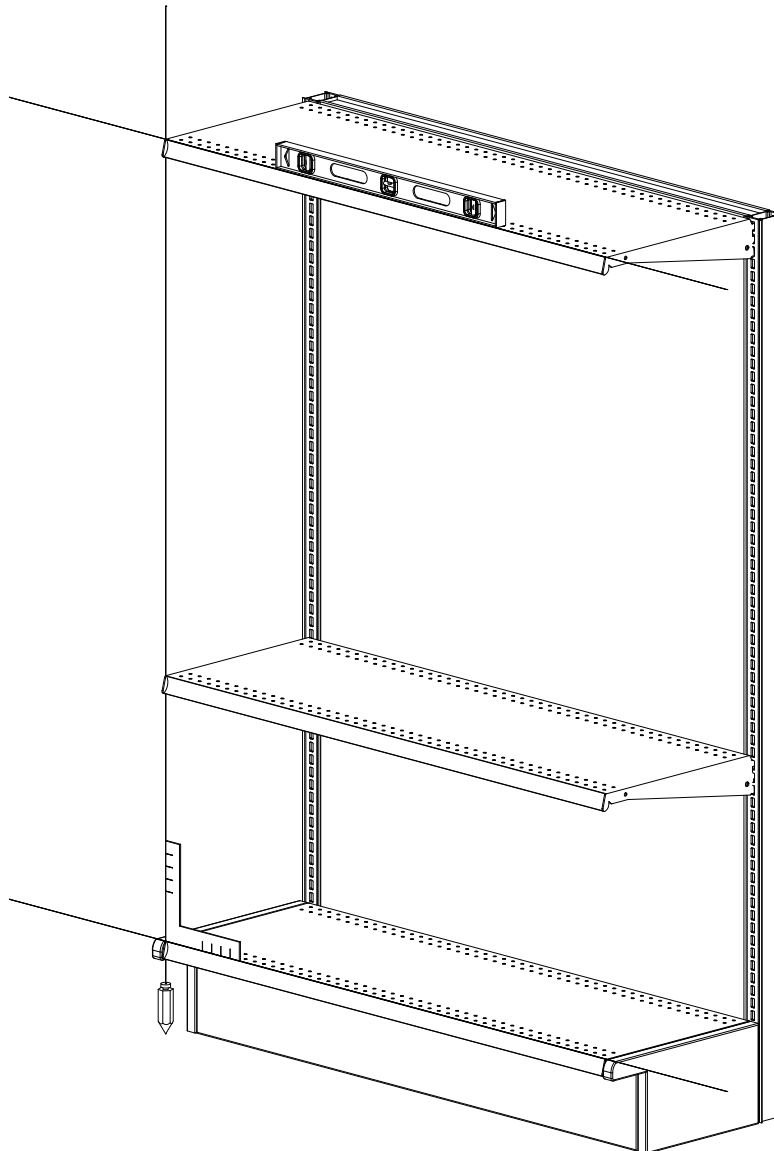

Step 2: Assemble Rolling Doors Frame and install bumpers using hardware provided as shown.

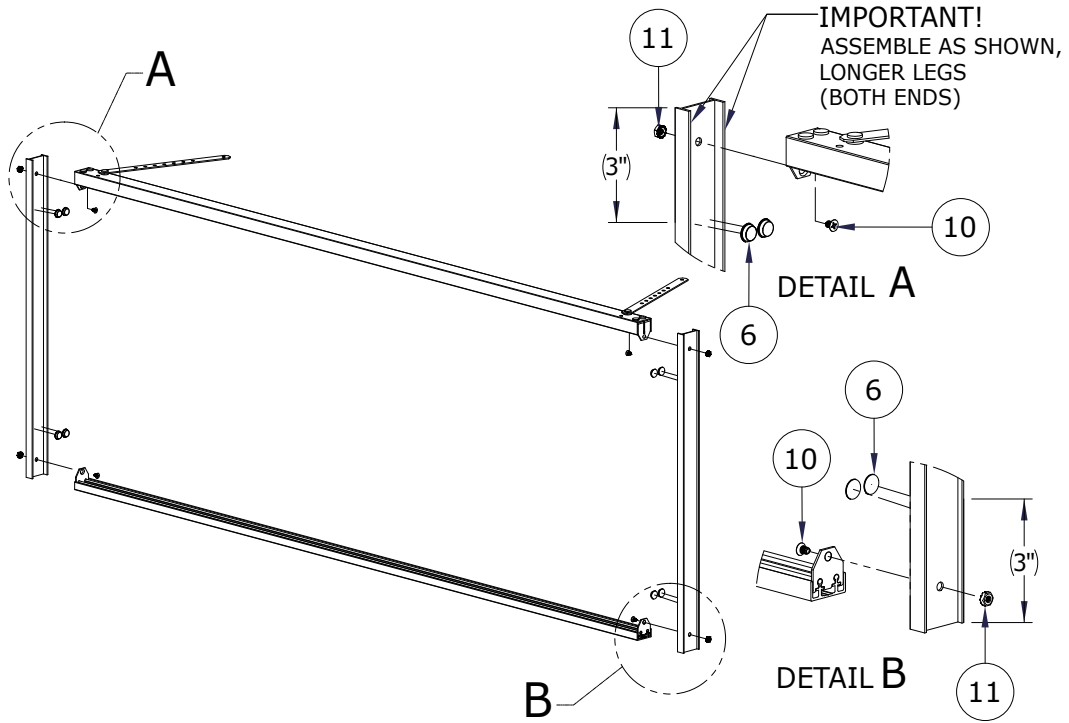

Step 3: With the anchor straps orientated towards the back, position the assembled Rolling Door Frame onto the shelf so that it is centered left to right and the first set of holes in the shelf align with the holes in the bottom track.

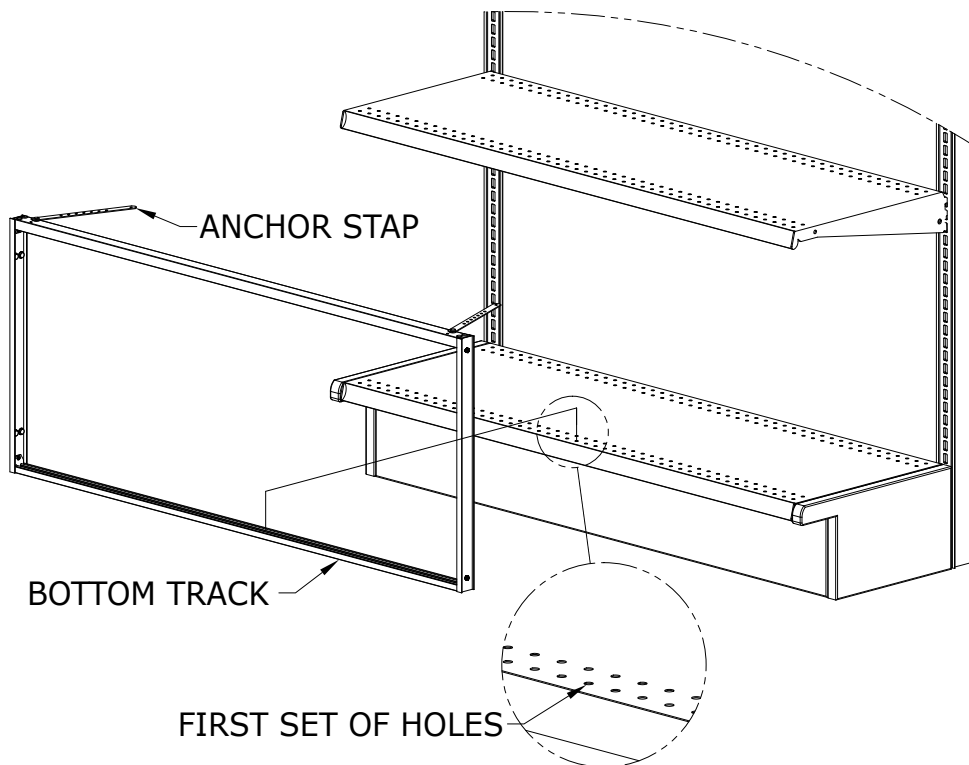

Step 4: Loosely install hardware provided into the Bottom Track and shelf, hand tighten only allowing for minimal adjustment as shown.

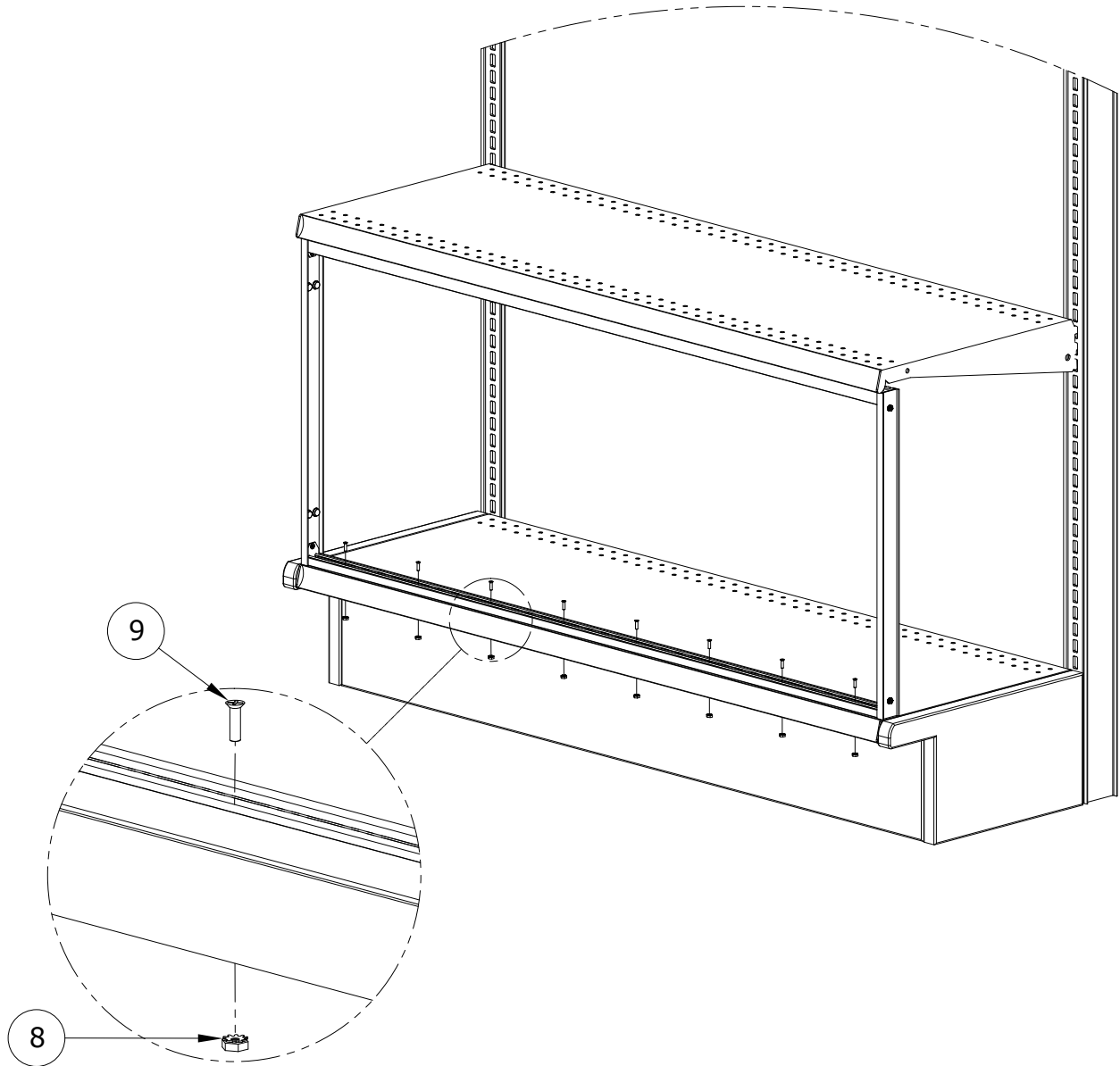

Step 5:

- Align Jambs so they are flush with the shelf edge on both ends.
- Ensure a consistent gap between the entire width of the shelf edge and the bottom track edge.
- Ensure the Jambs are equal distance from the slotted standards at the bottom and the top of the Jamb on both ends.
- Now, tighten up hardware in Bottom Track to shelf from Step 4.

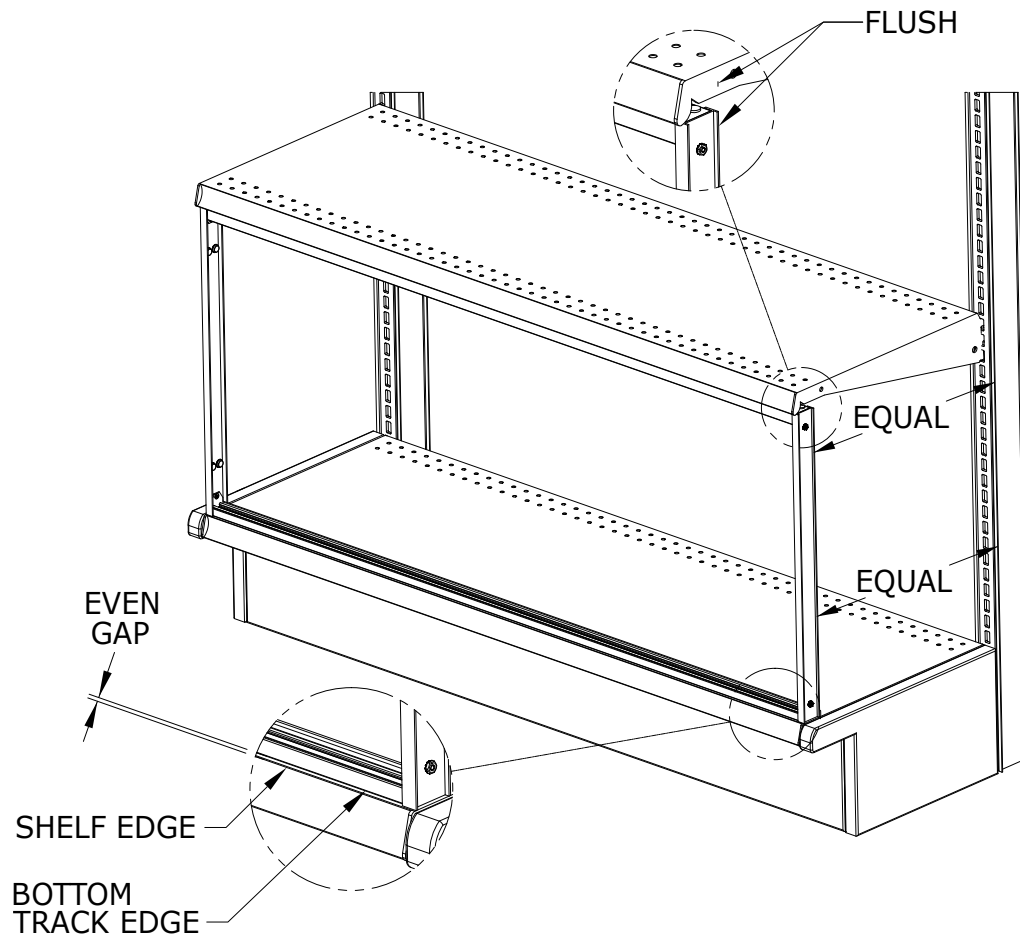

Step 6:

- Rotate Anchor Straps over Shelf Support Channel so that 2 mounting holes in each Anchor Strap align with Shelf Support Channel for attachment.
- Using drill screws provided, fasten the 2 Anchor Straps to the Shelf Support Channel using 4 drill screws as shown.

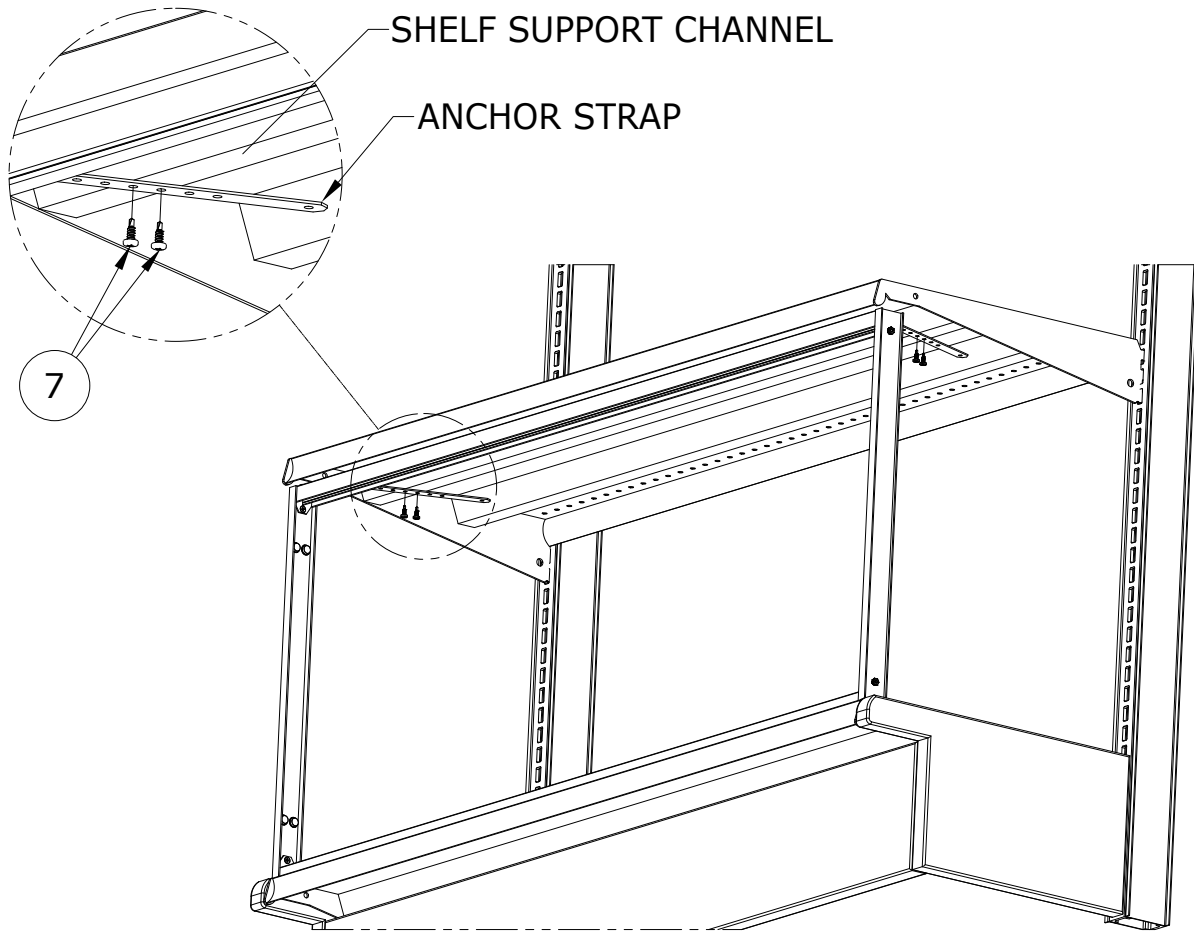

Step 7: Installing Left Rear Door into Top Track Rear Channel and onto Bottom Track Rear Rail.

1. At a slight angle, lift the top of the door up and into the Top Track Rear Channel.
2. With the top of the door in the Top Track Rear Channel, locate the bottom of the door over and onto the Bottom Track Rear Rail.
3. Slowly slide the door all the way to the left then slowly to the right so the Security Retainers drop down into the Security Notch located at the center of the Bottom Track.

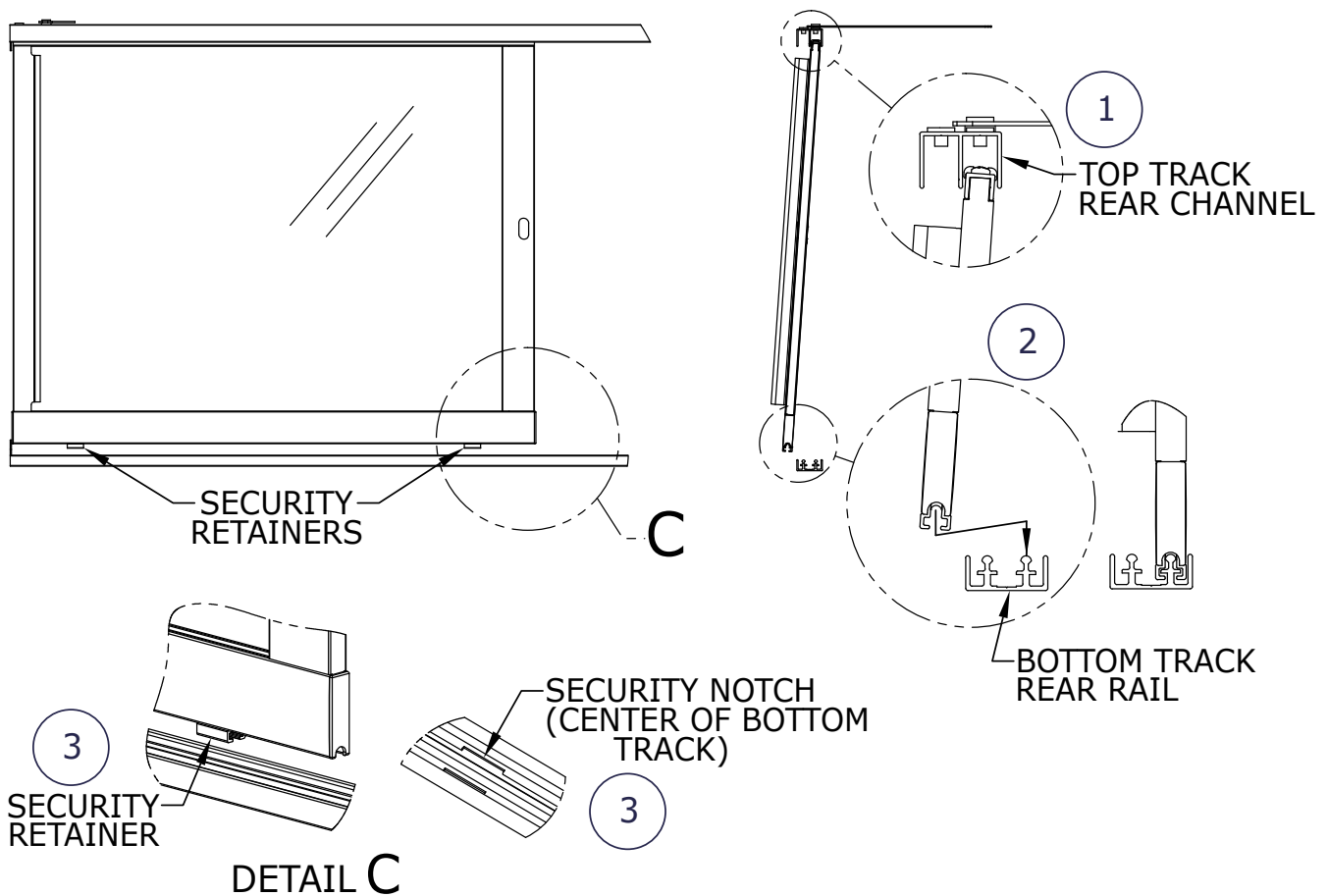

Step 8: Installing Right Front Door into Top Track Front Channel and onto Bottom Track Front Rail. (Before installing the door with lock, ensure the lock is in the unlocked position so the plunger is not engaged).

1. At a slight angle, lift the top of the door up and into the Top Track Front Channel.
2. With the top of the door in the Top Track Front Channel, locate the bottom of the door over and onto the Bottom Track Front Rail.
3. Slowly slide the door all the way to the left then slowly to the right so the Security Retainers drop down into the Security Notch located at the center of the Bottom Track.

