



Installation Instructions

Optima 300 LED Edge-Lit Single-Sided Light Box

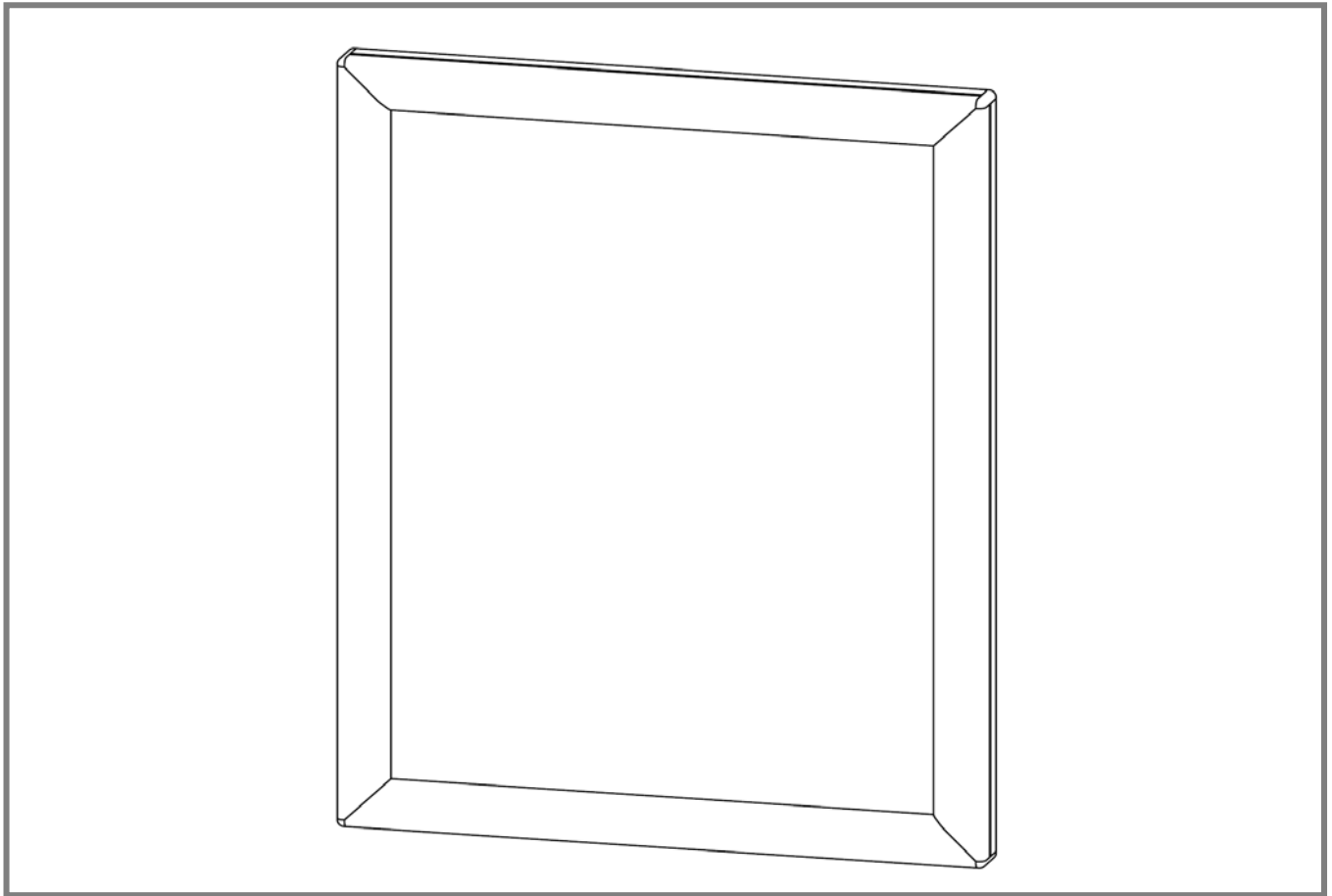

Figure 1

INSTALLATION INSTRUCTIONS

Before you begin

These instructions illustrate the Stylmark Optima 300 LED Edge-Lit Single-Sided Light Box. If you have questions during assembly, call 800-328-2495 to request technical assistance.

Tools you'll need

- Phillips screwdriver
- Pencil
- Level
- 1/4" Drill (varies by application)

Please read these instructions carefully before beginning installation.

Part Number# 971783
Rev B (5/16)

Stylmark Installation Instructions: Optima 300 LED Edge-Lit Light Box

Getting Started:

These instructions are for Optima 300 LED Edge-Lit Single-Sided Light Box. Standard mounting kit is included with assembly.

Please review all electrical requirements on the label before connecting. **Do not use improper current.**

This sign is intended to be installed in dry locations only and in accordance with the requirements of Article 600 of the National Electrical Code and/or other applicable local codes. This includes proper grounding and bonding of the sign.

Step-by-Step Instructions:

1. Determine if you are hanging the light box vertically or horizontally. Figure 2 shows the approximate locations for installing the mounting clips. **See Figure 2.**
2. Insert the supplied mounting clips into the groove on the top rear of the frame at an angle of approximately 45 degrees. **See Figure 3.**
3. If the locking screw is already installed in the mounting clip, remove it and then, using your thumb, apply pressure to the upper portion of the clip, snapping it into the channel. **See Figure 3.**
4. Slide each mounting clip to the desired location and then insert and tighten the locking screws. **See Figure 4 & 5.**

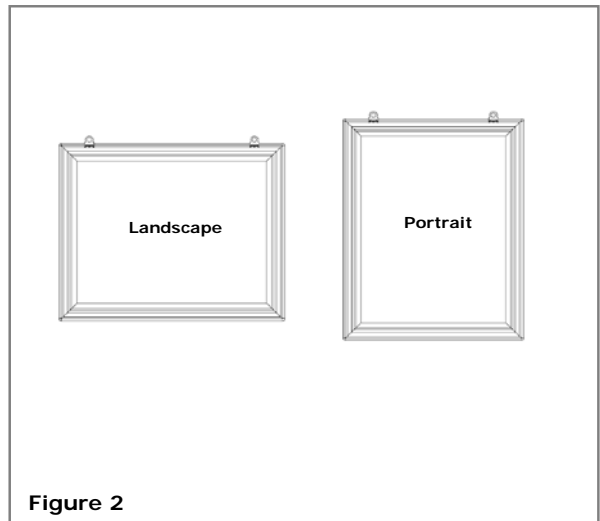

Figure 2

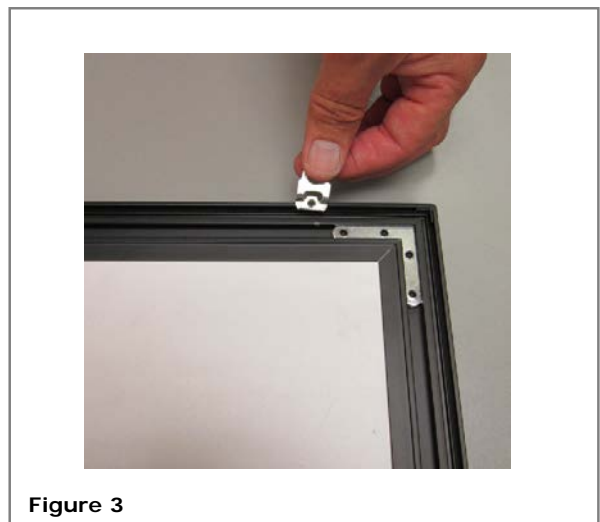

Figure 3

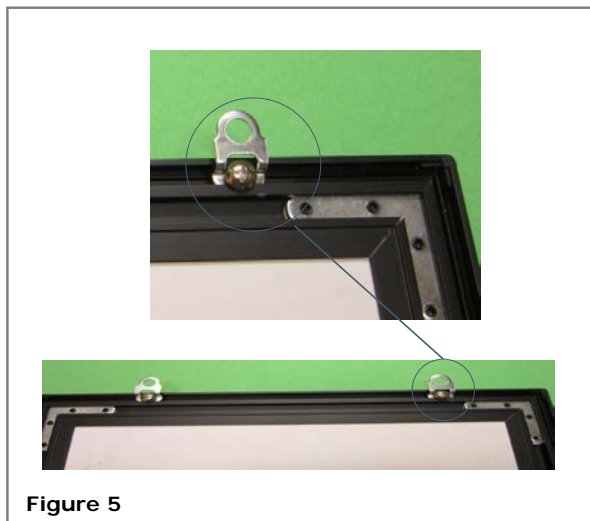

Figure 5

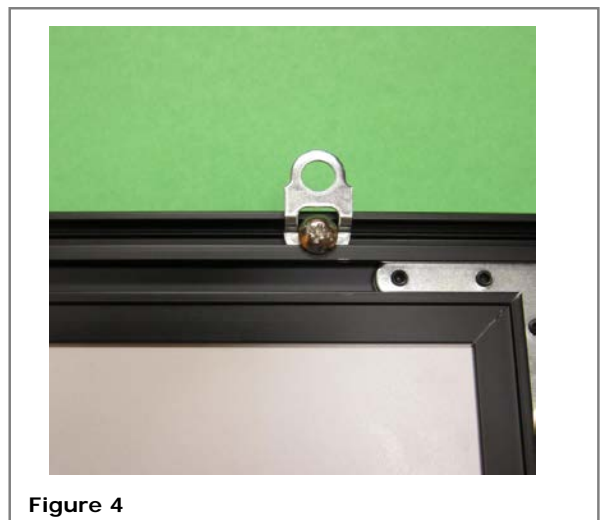

Figure 4

Part Number# 971783
Rev B (5/16)

Stylmark Installation Instructions: Optima 300 LED Edge-Lit Light Box

Step-by-Step Instructions Continued:

5. Hold the light box in the desired location on the wall, check to make sure the frame is level, and mark the positions of the mounting screws through the holes in the mounting clips. Drill a ¼" hole at each mark and insert the plastic anchors. Using a Phillips head screw driver, insert the screws, leaving about ¼" exposed. **See Figure 6.**
6. Mount the light box by lifting it until the mounting clips fit over the exposed screw heads. If necessary, the mounting clips can be repositioned by loosening the locking screws. **See Figure 7.**

Step-by-Step Instructions – Connect Power Supply:

1. Connect the DC power cord from the unit to the DC power connector from the power supply. **See Figure 8.**
1. Connect the AC power cord to the AC inlet in the power supply. **See Figure 9.**
2. Connect the AC power cord to the wall outlet.

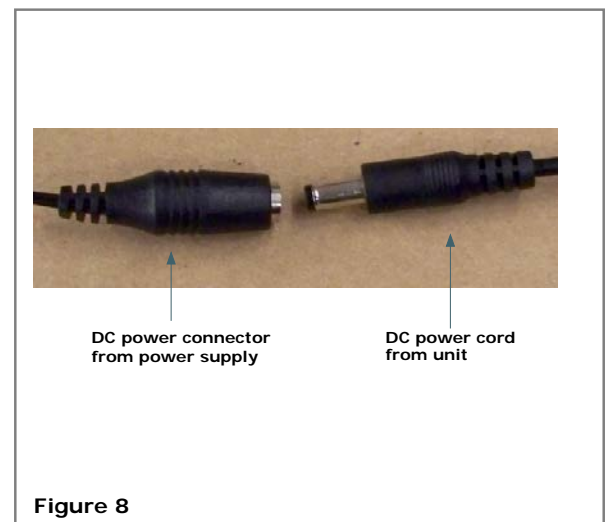
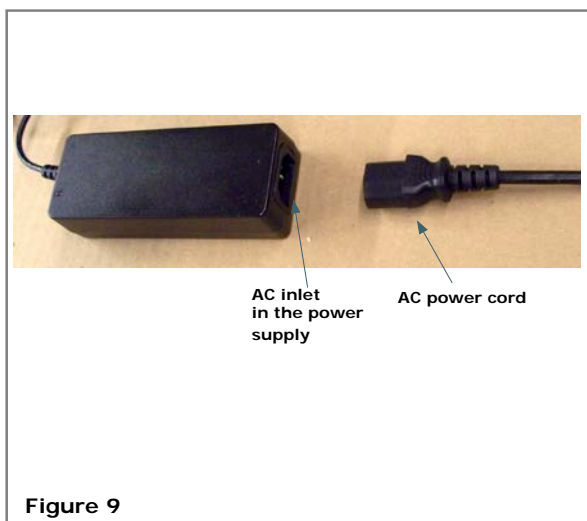
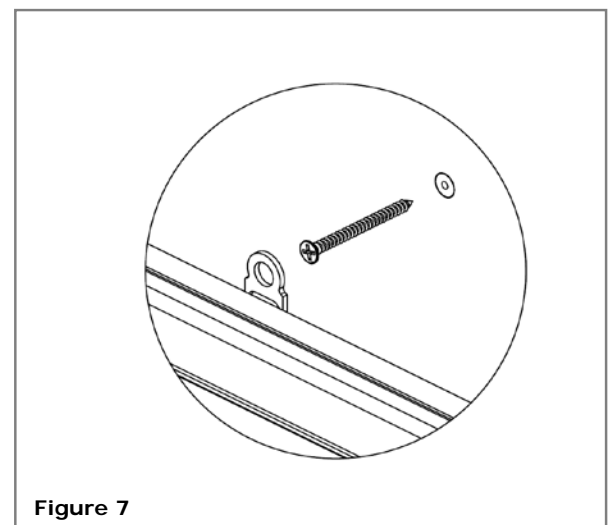
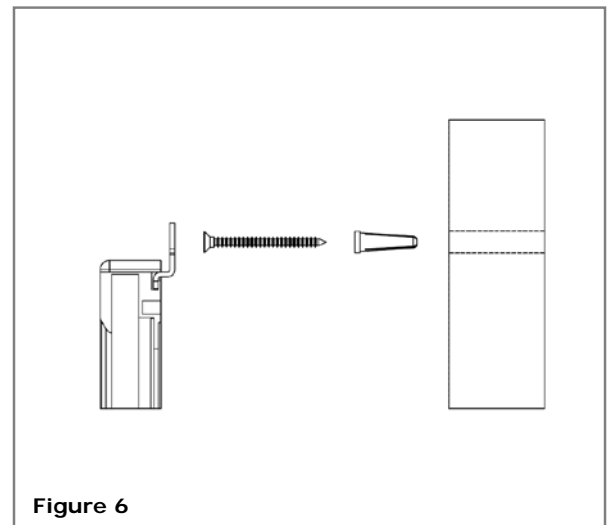

Part Number# 971783
Rev B (5/16)

Stylmark Installation Instructions: Optima 300 LED Edge-Lit Light Box

Acrylic Care and Maintenance

Storage

The Optima™ LED Edge-Lit Light Box should not be stored near heat sources, as heat tends to soften and deform acrylic sheets. Do not store sheets near spray painting booths or expose them to other solvent vapors.

Caring for Acrylic Panel

Washing

Wash the acrylic panel with a solution of mild soap or detergent and lukewarm water. Use a clean soft cloth, applying only light pressure. Rinse with clean water and dry by blotting with a damp cloth or chamois. Grease, oil, or tar may be removed with a good grade of hexane, aliphatic naphtha, or kerosene.

DO NOT USE: Window cleaning sprays, kitchen scouring compounds or solvents such as acetone, gasoline, benzene, alcohol, carbon tetrachloride, or lacquer thinner. These can scratch the sheet's surface and/or weaken the sheet causing small surface cracks called, "crazing."

Dusting

Dust with a soft, damp cloth or chamois. Dry or gritty cloths may cause surface scratches and create a static electric charge on the surface.

Polishing

Protect the acrylic panel and maintain its surface gloss by occasional polishing with a good plastic cleaner and polish. Apply a thin, even coat with a soft clean cloth and polish lightly with cotton flannel. Wipe with a damp cloth to help eliminate electrostatic charges that can attract dust particles.

Neutralizing Static Electricity

Static electrical charge can develop on the acrylic panel during handling and installation. Static electricity attracts dust, chips, etc. floating in the air or on nearby work surfaces and holds these contaminants tightly to the surface. Compressed air will remove much of this surface dirt. Several anti-static cleaners for plastics are also available which will reduce static electricity and dust attraction. Wiping with a soft damp cloth or chamois is all that is necessary to keep acrylic sheet dust-free between applications of these cleaners.

Removing Scratches

Fine scratches can be removed by hand polishing. Apply a plastic scratch remover to a soft flannel pad and rub. When the scratches have disappeared, remove all residue and polish. For deeper scratches, first sand lightly with a 400-grit "wet or dry" sandpaper, using plenty of water and rinsing the sandpaper frequently. Follow by buffing with a clean muslin wheel and a good polishing compound. For the highest gloss, use a clean-up wheel made of soft cotton or flannel sections and on which no compound is used. An electric drill with a buffing wheel is ideal.

ADDITIONAL TECHNICAL INFORMATION

Fire Precautions

Acrylic sheet is a combustible thermoplastic. Precautions should be taken to protect this material from flames and high heat sources. Acrylic sheet usually burns rapidly to completion if not extinguished. The products of combustion, if sufficient air is present, are carbon dioxide and water. However, in many fires, sufficient air will not be available and toxic carbon monoxide will be formed, as it will when other common combustible materials are burned. We urge good judgment in the use of this versatile material and recommend that building codes be followed carefully to assure it is used properly.

Compatibility

Like other plastic materials, acrylic sheet is subject to crazing, cracking, or discoloration if brought into contact with incompatible materials. These materials may include cleaners, polishes, adhesives, sealants, gasketing or packaging materials, cutting emulsions, etc.

Part Number# 971783
Rev B (5/16)