



# 2022 Net Price List

*Prices effective April 1, 2022*

*To learn more about the products in this price book, you can view the entire Stylmark product catalog on our website - [stylmark.com](http://stylmark.com)*

*You can also visit our online store to purchase select items. [shop.stylmark.com](http://shop.stylmark.com)*

Stylmark, Inc.  
6536 Main Street NE, PO Box 32008  
Minneapolis, MN 55432

Phone: 800-328-2495 763-574-7474 Fax: 763-574-1415  
[stylmark.com](http://stylmark.com) [info@stylmark.com](mailto:info@stylmark.com)



# 2022 Net Price List

Contents	Page
Terms & Conditions . . . . .	<a href="#">1</a>
Stylmark Warranty Statement . . . . .	<a href="#">7</a>
Price List Column Descriptions. . . . .	<a href="#">8</a>
Extrusions, Hardware and Accessories (listed numerically by part number) . . . . .	<a href="#">9</a>
Rolling Doors . . . . .	<a href="#">67</a>
Admire LED Mirror . . . . .	<a href="#">68</a>
Cafe Barrier System. . . . .	<a href="#">70</a>

---

6536 Main Street NE, PO Box 32008  
Minneapolis, MN 55432

Phone: 800-328-2495 763-574-7474 Fax: 763-574-1415  
stylmark.com info@stylmark.com

# Terms & Conditions

To place an ORDER or obtain a QUOTE, please call  
800-328-2495 or 763-574-7474  
Fax 763-574-1415 • info@stylmark.com

## Placing an Order

You may place an order via the Stylmark eCommerce site ([shop.stylmark.com](http://shop.stylmark.com)), email, or phone. When placing an order, please specify the part number along with the finish number. Refer to our catalog to verify the stock lengths and the buffed/brushed finished surfaces. All buffed or brushed finishes may be purchased as non-buffed or non-brushed as well. Order acknowledgements will be sent for review.

\*All order change requests are subject to additional charges.

## Minimum Order Amount

Product	Amount
Stocked Finished Goods (inc. hardware, wheels, screws, etc.)	\$ 100.00
Stocked (Finished) Extrusions	\$ 100.00
Non-Stocked Extrusions (Std Colors, per color) <sup>1</sup>	\$ 500.00
Non-Stocked Extrusions (Special Colors, per color) <sup>2</sup>	\$ 500.00
Non-Stocked Extrusions (Custom Colors, per color) <sup>3</sup> (See page 6 for additional Custom Color Information)	\$1,000.00
Fabricated Items (from Finished Goods Stock)	\$ 500.00
Fabricated Items / Curving (Orders will be evaluated)	Must be Quoted

\* minimum item quantities may apply to all orders

<sup>1</sup> Standard colors include: Natural, Black, Brown, Brass and Stainless Steel.

<sup>2</sup> Special colors include: Bronze, White Gold, Pewter and Copper.

<sup>3</sup> Custom colors include anything not listed above or special color matches.

**Due to recent issues with material and labor shortages, factory capacity on specific colors, Lead Times on all new orders will be reviewed and quoted based on current conditions.**

We apologize in advance for any inconvenience

# Terms & Conditions

To place an ORDER or obtain a QUOTE, please call  
800-328-2495 or 763-574-7474  
Fax 763-574-1415 • info@stylmark.com

## Prices

Prices are subject to change without notice. Orders are shipped at prevailing prices at the time of the order. Quotes are valid for 30 days from the date of quote, unless otherwise specified. Prices do not include applicable sales taxes and delivery charges, which will be added to your order.

## Taxes

Taxes are based on delivery address. If the company or job is tax exempt, please include a copy of the Tax Exemption Certificate with the order.

## Methods of Payment

With approved credit, we will ship your order on an open 30-day account. To open an account, simply request a credit application. The credit approval process may take 1-2 weeks. To expedite your first order, we recommend paying with cash-in-advance. Open accounts are subject to 1%-15 days/net 30 terms.

We accept Visa, Mastercard, Discover and American Express. Prepayment by check is also an acceptable method. Credit card or prepayment by check are not eligible for the prompt payment discount. Call our Customer Service Department for details.

## Delivery

All orders are shipped F.O.B. Stylmark. Larger orders and 12' lengths are shipped freight via truck lines selected by Stylmark, unless otherwise specified by the customer.

Smaller orders and extrusions cut to 8' or less are shipped best way parcel, prepaid & add unless otherwise specified. Shipping and handling charges for parcel shipments are added to your invoice. Expedited shipping available upon request.

All freight and processing fees will be charged to the customer if collect freight terms are no longer active or in good standing with the client's chosen freight company.

*Special delivery requirements?*

*Please let us know and we will do everything we can to meet your needs.*

# Terms & Conditions

To place an ORDER or obtain a QUOTE, please call  
800-328-2495 or 763-574-7474  
Fax 763-574-1415 • info@stylmark.com

## International Shipping

Preferred payment options for international customers would be a wire transfer. A wire transfer fee will be charged.

Stylmark currently does not arrange international transportation. Customers are responsible to coordinate transportation internationally to their locations. (Exception for parcel shipments to Canada).

## Prepay and Add Freight

Eliminate the hassles associated with collect freight deliveries and let us find the most economical rate to meet your requested delivery. We will share the benefits of our established relationships with multiple carriers and pass those savings on to you. To take advantage of this new option, simply talk to your customer service representative when you are ready to place your order. Once your order is completed and in shipping, our staff will compare rates and service levels and select the one that best fits your needs. This option is available to customers with established terms or those that remit via credit card.

NOTE: A second debit for shipping charges will be charged against the credit card when the order ships.

NOTE: Additional freight and accessorial charges prepaid by Stylmark will be invoiced separately.

## Customer Pick-Up Policy

Once complete and packaged for shipment, customer pickup orders will be transacted and you will be invoiced accordingly. As always, our shipping team will notify you that your order is ready and provide you with the weights & dimensions of your order.

\* All orders are to be picked up as soon as possible (within 3 days) after you have been notified. If orders are not picked up within this timeframe, Stylmark reserves the right to apply additional holding charges, including shipping the order via best method at your expense.

## Limited Warranty

Stylmark products are warranted to be free from defects in workmanship and materials under normal use and service when properly installed. This warranty is limited to actual invoiced charges; we are not liable for any other damages or charges. Refer to Stylmark's complete warranty statement on page 9 for further details.

# Terms & Conditions

To place an ORDER or obtain a QUOTE, please call  
800-328-2495 or 763-574-7474  
Fax 763-574-1415 • info@stylmark.com

## Anodizing Range Samples

Stylmark strives to provide consistent and uniform anodized finishes; however, variation in gloss, light & dark, and tristimulus system values (RGB) should be expected. Additionally, because anodized coatings are translucent, appearance will vary with viewing angle and base level finish of material. Therefore, for critical installations, minimum/maximum samples which represent the acceptable range of variation in the finish should be requested & approved prior to processing any orders. Without approved range samples, Stylmark will produce orders using standard range tolerances around the target anodized finish.

## Anodized Aluminum Racking Marks

All anodized aluminum extrusion and parts must have electrical contact to the part to be anodized. Various contact types are used depending upon the size and geometry of the part being anodized. The electrical contact will leave racking marks on the finished parts. Racking marks include bolt marks, clip marks or thread marks. Most extrusions will include bolt marks, and for this reason, Stylmark's typical extrusion length is 2" over its nominal length, e.g., a 12 ft extrusion measures to 146". This way the user of the finished extrusion can trim the extrusion to size and have 12 ft of useable, finished material. Other anodized aluminum parts, such as anodized sheet aluminum may also have bolt or clip marks. Please verify allowable locations or contact Stylmark for options. Cut to length extrusions and machined parts may be racked using clips. Although clips leave smaller rack marks, they are generally placed in the least conspicuous locations possible as to minimize the appearance of the mark. It is important to communicate the critical surfaces & finish expectation to Stylmark so we can work with you to identify acceptable rack mark locations. Heavier materials, such as machined items or parts made from aluminum plate may require the electrical contact to be made in a tapped hole in the part. In this case, the rack mark will be in and around the threads of the tapped hole, where the bolt threads engage the part. If racking marks are a concern for the anodized materials on your project, you are encouraged to contact Stylmark, prior to placing your order, to discuss racking options.

## Custom Color Charges

Stylmark has an extensive library of colors. Custom colors will be subject to an additional charge. If you have a color to match or would like a custom color, please call for details.

*\* Minimum order quantities and longer lead times will apply.*

# Terms & Conditions

To place an ORDER or obtain a QUOTE, please call  
800-328-2495 or 763-574-7474  
Fax 763-574-1415 • info@stylmark.com

## Order Quantity Tolerances

Orders for non-stocked, made-to-order items are subject to a quantity range tolerance of +/- 10% and these items may also be subject to a minimum quantity per item. This includes all FTOE's (Finish-to-Order Extrusions) and all other products not held in Finished Goods inventory by Stylmark.

For example, for an order of 40 pieces of a made-to-order item, we may deliver 36-44 pieces, bill the actual quantity shipped at the quoted unit price and close the order.

## Special Order Extrusion Quantity Tolerances

All special-order extrusions are subject to quantity range tolerances as described below.

Extrusions Push	Piece Part Yield
300-400 pounds	+/- 35%
400-700 pounds	+/- 30%
700-1,000 pounds	+/- 25%
1,000-2,000 pounds	+/- 15%
2,000-5,000 pounds	+/- 10%
5,000-10,000 pounds	+/- 7%
10,000-30,000 pounds	+/- 5%

For example, an order for 200 pieces of a special-order extrusion may require a 300 lb extrusion push based upon profile weight. This push may yield 200 pieces +/- 35% of the extrusion. Stylmark will ship the entire yield (for this example 140-270 pieces) of the push and you will be invoiced for the quantity shipped at the quoted unit price.

\* Exact quantity orders will be subject to additional charges.

## Extrusion Dies and Tooling

Unless otherwise designated in writing, all extrusion dies and tooling remains the property of Stylmark. We hold tooling for a minimum of two years. If no order is received in any two-year period, we reserve the right to dispose of the tooling.

# Terms & Conditions

To place an ORDER or obtain a QUOTE, please call  
800-328-2495 or 763-574-7474  
Fax 763-574-1415 • info@stylmark.com

## Design/Engineering Charges

For customer requesting design or engineering work, a charge of \$150 per hour will apply.

## Patents

On orders for customer-specified products, the customer agrees to protect and indemnify Stylmark against any infringement claims.

## Shortages and Damaged Shipments

Claims for shortages and damages must be submitted in writing within 5 days of order shipment. Receiver must note damage on BOL at time of delivery. Provide signed BOL, photos of damaged material and packaging to process a claim for replacement. Stylmark will file a freight claim for damage and shortages on prepaid shipments if notified within 5 days of receipt. Keep damaged goods and packaging for inspection until advised by the carrier to dispose of them.

## Return Policy

Stylmark's goal is 100% customer satisfaction. Returned materials should be wrapped for protection and tightly bundled to prevent movement in shipping. We cannot accept returns of materials that have been damaged during return shipment due to improper packaging. All returns are subject to Stylmark approval and require a RMA.

*\* Contact your Stylmark account representative and request a Return Material Authorization (RMA) number. Please do not return materials to us without first obtaining an RMA number. Provide an order or invoice number and reason for return request.*

*\* Return the materials to us (shipped pre-paid) within 21 days of authorization, clearly marking each package with the RMA number. Include the RMA number on the packing slip. Returns shipped freight collect will be back charged for freight.*

*\* Under normal conditions, returns are only allowed on standard stock items in standard finishes and will be subject to a restocking charge (typically 25% or \$50, whichever is greater).*

*\* All material returned will be credited using quantity discount price unless referenced on invoice.*

*\* Upon inspection and approval, a credit will be issued to your account.*



# Stylmark Warranty Statement

Stylmark, Inc. warrants this product to be free from defects due to workmanship or materials, under normal use and service, for the following warranty period from date of shipment.

## Lighting Products:

- Showcase & Flexis Shelf Lights with 24V LED: twenty-four (24) months
- LED Mirror Products: twenty-four (24) months
- Optima LED Light Boxes: twenty-four (24) months

All other products: thirty (30) days

Any product that is proven to be defective in workmanship or material is returned to Stylmark, Inc. within the applicable warranty period, in accordance with the procedure described below, Stylmark, Inc. will, at its option, either repair, replace or credit the customer for the purchase price of the product, in accordance with the procedure described below. This warranty extends only to persons or organizations that originally purchase the product from Stylmark, Inc.

The expressed warranty above constitutes the entire warranty of Stylmark, Inc. with respect to the products in this catalog and is in lieu of all other warranties, express or implied, including any warranty of merchantability or warranty of fitness for a particular purpose. In no event shall Stylmark, Inc. be responsible for any other costs or damages, including, but not limited to, lost revenue or profits, incidental, special or consequential damages of any nature whatsoever. Stylmark, Inc. products are designed to operate as a system. The use of other manufacturers' equipment in conjunction with Stylmark, Inc. products may be hazardous and therefore automatically voids all warranties. This warranty shall not apply to products that have been altered, improperly used or installed, subject to abnormal use or stress, or repaired by anyone other than Stylmark, Inc. authorized representative. Stylmark, Inc. will not pay labor charges or assume any responsibility for labor expended or material used to replace or repair any equipment without prior written authorization.

The following will apply to the return of any product to Stylmark, Inc. under this warranty:

- identified with Stylmark, Inc. Return Material Authorization Number;
- listed individually with Sales Order Number or copy of invoice;
- packed separately from other returns and protected from shipping damage;
- returned to Stylmark, Inc. within the applicable warranty period;
- are received, transportation pre-paid (returns shipped collect will be back-charged for freight), within 21 days of authorization at (see address below);
- and are found by Stylmark, Inc. inspection to be defective in workmanship or materials under normal use and service; will be handled in accordance with one of the two following procedures, as determined by Stylmark, Inc.:  
Credit Procedure. Stylmark, Inc. will issue credit at the actual invoice amount if a copy of that invoice is attached to the packing list. Without an invoice, Stylmark, Inc. will credit using discount pricing.

Repair or Replacement Procedure. Stylmark, Inc. will, at its option, either repair or replace the product free of charge and return it or its replacement lowest cost transportation pre-paid. The replacement will be a functionally equivalent new product. Premium transportation will be used at customer's request and expense.

The warranty will not be honored if:

- product is damaged or missing parts or accessory items.
- product exhibits evidence of field misapplications

Final disposition of any warranty claim will be determined solely by Stylmark, Inc. If inspection by Stylmark, Inc. does not disclose any defect covered by the warranty, the product will be returned or scrapped as instructed by the customer and Stylmark, Inc.'s regular service charges will apply. Products returned to the customer may be sent shipping charges collect.

If you have any questions relative to product returns to Stylmark, Inc., contact your Customer Service Representative:  
Stylmark, Inc.

Customer Care Department  
6536 Main Street NE, PO Box 32008  
Minneapolis, MN 55432  
(800) 328-2495

## Price List Column Descriptions

Part Number	Description	Cat. Page Ref.	View	Finish	Discount Quantity Pricing <span style="float: right;">⑦</span>				
					1-5	6-10	11-24	25-99	100+
①	②	③	④	⑤ Non-Buffered Non-Brushed					
				⑥ Buffered or Brushed					









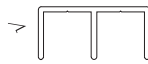
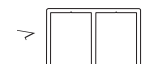

- ① **Part Number** = Stylmark's part number for the item.
- ② **Description** = Brief description of the item.
- ③ **Catalog Page Reference** = This is where you will find the item in the Stylmark Catalog. The following abbreviations are used to indicate a section of the catalog: SP=Shelving Products, S>Showcases, FP=Framing and Partition Systems, AT=Architectural Trim and Moldings, BD=Backlit Displays and Transparency Frames, FR=Fitting Rooms, HA=Hardware and Accessories
- ④ **View** = Side profile of the extrusion's shape. Check-marks indicate mechanically finished surfaces for buffed/brushed finishes. Views are representative only - they are not to scale or in proportion to each other.
- ⑤ **Non-Buffered, Non-Brushed Finish** = This includes Stylmark's Satin Natural Finish, number 020, and other non-buffed, non-brushed colored finishes. Minor material blemishes may appear in this finish, as it is not buffed or brushed.
- ⑥ **Buffered or Brushed Finish** = This includes the following Stylmark finishes (\* see table below).
- ⑦ **Discount Quantity Pricing Price** = This is the price of the item when ordered in quantities. All extrusions are priced per 12 foot stock length, unless indicated otherwise.





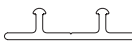

**\* Ref item 6**

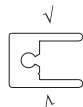

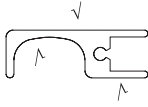
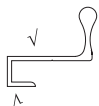
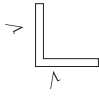

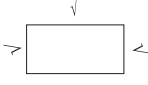
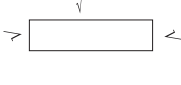

110 Buffed Brite Natural	123 Buffed Satin Black	216 Brushed Brite Brown
111 Buffed Brite Brass	124 Buffed Satin White Gold	217 Brushed Brite Pewter
112 Buffed Brite Bronze	126 Buffed Satin Brown	218 Brushed Brite Stainless Steel
113 Buffed Brite Black	127 Buffed Satin Pewter	220 Brushed Satin Natural
114 Buffed Brite White Gold	128 Buffed Satin Stainless Steel	228 Brushed Satin Stainless Steel
116 Buffed Brite Brown	210 Brushed Brite Natural	11BRS80010 Buffed Brite
117 Buffed Brite Pewter	211 Brushed Brite Brass	Medium Light Brass
118 Buffed Brite Stainless Steel	212 Brushed Brite Bronze	11PWT80024 Buffed Brite
120 Buffed Satin Natural	213 Brushed Brite Black	Medium Light Pewter
121 Buffed Satin Brass	214 Brushed Brite White Gold	
122 Buffed Satin Bronze		

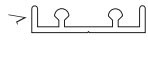

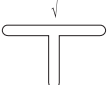

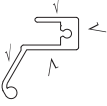
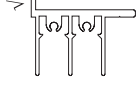
Many of the above listed finishes are sampled on our color/finish card; other sample color chips are available upon request.

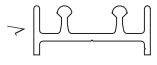

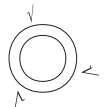
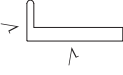
**Finishes other than those listed here are available. For painted, powder coated, or other custom colors and finishes, please call our Customer Service Department.**

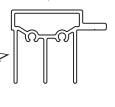

Part Number	Description	Cat. Page Ref.	View	Finish	Discount Quantity Pricing				
					1-5	6-10	11-24	25-99	100+
110007	Double Channel 9/16", 12 ft.	RD13		Non-Buffered Non-Brushed	19.24	18.47	18.09	17.70	16.93
				Buffered or Brushed	23.77	22.82	22.34	21.87	20.92
110008	Double Channel 13/16", 12 ft.	RD13		Non-Buffered Non-Brushed	24.95	23.95	23.45	22.95	21.96
				Buffered or Brushed	30.75	29.52	28.91	28.29	27.06
110009	Drop-In Track, 12 ft.	RD13		Non-Buffered Non-Brushed	11.73	11.26	11.03	10.79	10.32
110012	Shoe, 12 ft.	RD13 SC9		Non-Buffered Non-Brushed	18.53	17.79	17.42	17.05	16.31
				Buffered or Brushed	25.47	24.45	23.94	23.43	22.41
110014	Glide Shoe, 12 ft. (works with 110021 Glide Track)	RD13		Non-Buffered Non-Brushed	15.00	14.40	14.10	13.80	13.20
				Buffered or Brushed	19.43	18.65	18.26	17.88	17.10
110018	Deep Tee 3/4", 12 ft.	HA27		Non-Buffered Non-Brushed	17.84	17.13	16.77	16.41	15.70
				Buffered or Brushed	24.38	23.40	22.92	22.43	21.45
110019	Double Track, 12 ft.	RD13		Non-Buffered Non-Brushed	17.51	16.81	16.46	16.11	15.41
110021	Glide Track, 12 ft. (works with 110014 Glide Shoe)	RD13		Non-Buffered Non-Brushed	15.16	14.55	14.25	13.95	13.34
110022	Single Channel 9/16", 12 ft.	HA7 RD13		Non-Buffered Non-Brushed	14.42	13.84	13.55	13.27	12.69
				Buffered or Brushed	18.82	18.07	17.69	17.31	16.56
110023	13/16" Single Channel, 12 ft.	HA10 RD13		Non-Buffered Non-Brushed	16.49	15.83	15.50	15.17	14.51
				Buffered or Brushed	23.38	22.44	21.98	21.51	20.57
110024	Edge Molding, 12 ft.	RD13 HA10 SC5		Non-Buffered Non-Brushed	12.16	11.67	11.43	11.19	10.70
				Buffered or Brushed	15.56	14.94	14.63	14.32	13.69
110026	Edge Molding, 12 ft.	HA10 RD13 SC5 S8		Non-Buffered Non-Brushed	17.27	16.58	16.23	15.89	15.20
				Buffered or Brushed	22.20	21.31	20.87	20.42	19.54

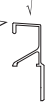
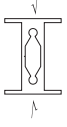
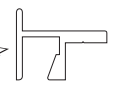
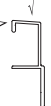
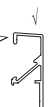
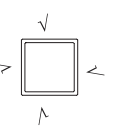
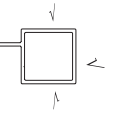
Part Number	Description	Cat. Page Ref.	View	Finish	Discount Quantity Pricing				
					1-5	6-10	11-24	25-99	100+
110027	Door Pull, 12 ft.	HA10 RD13		Non-Buffered Non-Brushed	19.85	19.06	18.66	18.26	17.47
				Buffered or Brushed	25.83	24.80	24.28	23.76	22.73
110028	Flush Door Pull, 12 ft.	HA23 RD13 SC5		Non-Buffered Non-Brushed	27.39	26.29	25.75	25.20	24.10
				Buffered or Brushed	37.75	36.24	35.49	34.73	33.22
110029	Door Pull, 12 ft.	HA23 RD13		Non-Buffered Non-Brushed	33.14	31.81	31.15	30.49	29.16
				Buffered or Brushed	43.20	41.47	40.61	39.74	38.02
110030	1/2" Angle, 12 ft.	HA3 SC15		Non-Buffered Non-Brushed	11.38	10.92	10.70	10.47	10.01
				Buffered or Brushed	15.70	15.07	14.76	14.44	13.82
110034	3/4" Angle, 12 ft.	HA3		Non-Buffered Non-Brushed	15.02	14.42	14.12	13.82	13.22
				Buffered or Brushed	20.17	19.36	18.96	18.56	17.75
110035	Slide Track, 12 ft. (use with 119006)	RD13		Non-Buffered Non-Brushed	13.57	13.03	12.76	12.48	11.94
				Buffered or Brushed	16.64	15.97	15.64	15.31	14.64
110036	Slide Double Channel, 12 ft.	RD13		Non-Buffered Non-Brushed	20.27	19.46	19.05	18.64	17.84
				Buffered or Brushed	22.47	21.57	21.12	20.67	19.77
110050	1" x 1/2" Bar, 12 ft.	HA16		Non-Buffered Non-Brushed	67.20	64.51	63.17	61.82	59.14
				Buffered or Brushed	72.85	69.94	68.48	67.02	64.11
110051	2" x 1/2" Bar, 12 ft.	HA16		Non-Buffered Non-Brushed	118.43	113.69	111.32	108.96	104.22
				Buffered or Brushed	129.60	124.42	121.82	119.23	114.05
110061	Jamb, 12 ft.	HA32 RD13		Non-Buffered Non-Brushed	20.58	19.76	19.35	18.93	18.11
				Buffered or Brushed	25.89	24.85	24.34	23.82	22.78
110063	Double Channel Track, 12 ft.	RD13		Non-Buffered Non-Brushed	20.11	19.31	18.90	18.50	17.70
				Buffered or Brushed	26.32	25.27	24.74	24.21	23.16

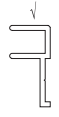
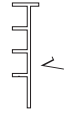

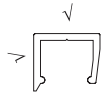
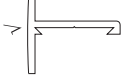
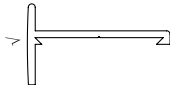
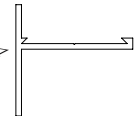
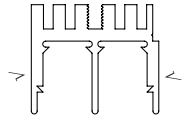
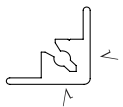
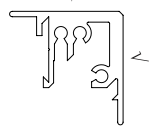
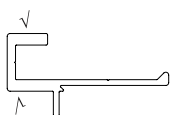

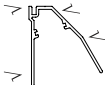
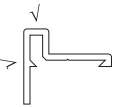
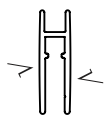
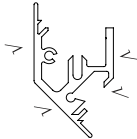

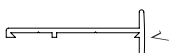
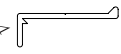
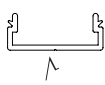
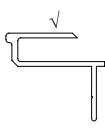
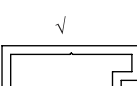
Part Number	Description	Cat. Page Ref.	View	Finish	Discount Quantity Pricing				
					1-5	6-10	11-24	25-99	100+
110065	Anti-Jump Strip, 12 ft.	RD13 HA27		Non-Buffered Non-Brushed	10.24	9.83	9.63	9.42	9.01
				Buffered or Brushed	12.13	11.64	11.40	11.16	10.67
110066	19° Shoe, 12 ft.	RD14		Non-Buffered Non-Brushed	44.53	42.75	41.86	40.97	27.21
				Buffered or Brushed	47.63	45.72	44.77	43.82	29.94
110067	Deep Shoe, 12 ft.	RD14		Non-Buffered Non-Brushed	25.02	24.02	23.52	23.02	22.02
				Buffered or Brushed	29.91	28.71	28.12	27.52	26.32
110069	Door Pull, 12 ft.	HA23 RD14 SC5		Non-Buffered Non-Brushed	26.59	25.53	24.99	24.46	23.40
				Buffered or Brushed	33.23	31.90	31.24	30.57	29.24
110071	Showcase Channel, 12 ft.	SC29 RD14		Non-Buffered Non-Brushed	61.53	59.07	57.84	56.61	54.15
				Buffered or Brushed	69.08	66.32	64.94	63.55	60.79
110076	35° Deep Shoe, 12 ft.	RD14		Non-Buffered Non-Brushed	49.88	47.88	46.89	45.89	30.16
				Buffered or Brushed	53.19	51.06	50.00	48.93	33.07
110078	Channel Track, 12 ft.	RD14		Non-Buffered Non-Brushed	26.16	25.11	24.59	24.07	23.02
				Buffered or Brushed	31.76	30.49	29.85	29.22	27.95
110079	Wood Door Track, 12 ft.	RD14		Non-Buffered Non-Brushed	18.90	18.14	17.77	17.39	16.63
110080	Top U-Channel, 12 ft.	RD14 SC5 HA10		Non-Buffered Non-Brushed	20.36	19.55	19.14	18.73	17.92
				Buffered or Brushed	25.48	24.46	23.95	23.44	22.42
110087	1/2" O.D. Tube, 3/64" thick, 12 ft.	HA29		Non-Buffered Non-Brushed	15.34	14.73	14.42	14.11	13.50
				Buffered or Brushed	17.26	16.57	16.22	15.88	15.19
110090	Showcase Angle, 12 ft.	HA3		Non-Buffered Non-Brushed	18.19	17.46	17.10	16.73	16.01
				Buffered or Brushed	22.99	22.07	21.61	21.15	20.23



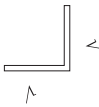
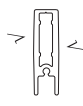
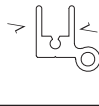

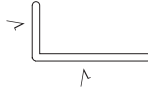
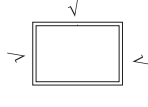
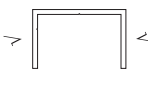

Part Number	Description	Cat. Page Ref.	View	Finish	Discount Quantity Pricing				
					1-5	6-10	11-24	25-99	100+
110093	13/16" Tee Molding, 12 ft.	HA27		Non-Buffered Non-Brushed	14.64	14.05	13.76	13.47	12.88
				Buffered or Brushed	18.59	17.85	17.47	17.10	16.36
110099	3/4" x 1/16" Reflector Strip, 12 ft.	HA16 SC29		Non-Buffered Non-Brushed	10.22	9.81	9.61	9.40	8.99
				Buffered or Brushed	14.61	14.03	13.73	13.44	12.86
110102	Top Rear Showcase Channel, 12 ft.	RD29		Non-Buffered Non-Brushed	68.17	65.44	64.08	62.72	59.99
				Buffered or Brushed	73.39	70.45	68.99	67.52	64.58
110104	3/4" - 4° Slant Top Drawer Pull, 12 ft. (410101 - 3-3/4" Pull)	HA23		Non-Buffered Non-Brushed	42.00	40.32	39.48	38.64	36.96
				Buffered or Brushed	48.20	46.27	45.31	44.34	42.42
110105	13/16" Slant Top Drawer Pull, 12 ft. (410103 - 3-3/4" Pull)	HA23		Non-Buffered Non-Brushed	42.58	40.88	40.03	39.17	37.47
				Buffered or Brushed	49.09	47.13	46.14	45.16	43.20
110106	Mullion, 12 ft.	RD14 HA32 SC15		Non-Buffered Non-Brushed	68.79	66.04	64.66	63.29	60.54
				Buffered or Brushed	74.85	71.86	70.36	68.86	65.87
110107	Front Frame, 12 ft.	SC15 HA32		Non-Buffered Non-Brushed	25.96	24.92	24.40	23.88	22.84
				Buffered or Brushed	30.78	29.55	28.93	28.32	27.09
110108	3/4" Flat Guard Drawer Pull, 12 ft. (410114 - 3-3/4" Pull)	HA23		Non-Buffered Non-Brushed	36.92	35.44	34.70	33.97	32.49
				Buffered or Brushed	43.38	41.64	40.78	39.91	38.17
110111	Drawer Pull with Label Holder, 12 ft. (410123 - 3-3/4" Pull)	HA23		Non-Buffered Non-Brushed	51.97	49.89	48.85	47.81	45.73
				Buffered or Brushed	56.03	53.79	52.67	51.55	49.31
110113	1" Square Tube, 1/16" thick, 12 ft.	HA30		Non-Buffered Non-Brushed	36.43	34.97	34.24	33.52	32.06
				Buffered or Brushed	59.28	56.91	55.72	54.54	52.17
110114	1" Square Tube with Leg, 12 ft.	HA30		Non-Buffered Non-Brushed	44.75	42.96	42.07	41.17	39.38
				Buffered or Brushed	53.29	51.16	50.09	49.03	46.90



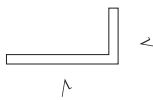

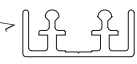
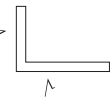
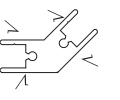
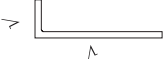
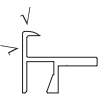
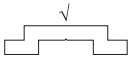





Part Number	Description	Cat. Page Ref.	View	Finish	Discount Quantity Pricing				
					1-5	6-10	11-24	25-99	100+
110119	Security Channel, 12 ft.	SC15 HA35		Non-Buffered Non-Brushed	18.26	17.53	17.16	16.80	16.07
				Buffered or Brushed	22.19	21.30	20.86	20.41	19.53
110122	Top and Side Glass Support, 12 ft.	SC15 HA35		Non-Buffered Non-Brushed	34.03	32.67	31.99	31.31	29.95
				Buffered or Brushed	36.98	35.50	34.76	34.02	32.54
110124	Base Channel, 12 ft.	HA35		Non-Buffered Non-Brushed	20.99	20.15	19.73	19.31	18.47
				Buffered or Brushed	26.03	24.99	24.47	23.95	22.91
110125	Glazing Channel, 12 ft.	HA35		Non-Buffered Non-Brushed	16.98	16.30	15.96	15.62	14.94
				Buffered or Brushed	23.45	22.51	22.04	21.57	20.64
110127	Top Front Frame, 12 ft.	HA32 SC15		Non-Buffered Non-Brushed	17.81	17.10	16.74	16.39	15.67
				Buffered or Brushed	23.15	22.22	21.76	21.30	20.37
110128	Top Frame Rear, 12 ft.	SC5		Non-Buffered Non-Brushed	28.63	27.48	26.91	26.34	25.19
				Buffered or Brushed	33.67	32.32	31.65	30.98	29.63
110129	Bottom Frame, 12 ft.	SC4		Non-Buffered Non-Brushed	23.42	22.48	22.01	21.55	20.61
				Buffered or Brushed	25.25	24.24	23.74	23.23	22.22
110130	Rear Header, 12 ft.	SC4		Non-Buffered Non-Brushed	75.04	72.04	70.54	69.04	66.04
				Buffered or Brushed	82.14	78.85	77.21	75.57	72.28
110131	Front Vertical, 12 ft.	SC8		Non-Buffered Non-Brushed	26.03	24.99	24.47	23.95	22.91
				Buffered or Brushed	30.07	28.87	28.27	27.66	26.46
110132	Rear Vertical, 12 ft.	SC4		Non-Buffered Non-Brushed	59.37	57.00	55.81	54.62	52.25
				Buffered or Brushed	68.17	65.44	64.08	62.72	59.99
110133	Jamb, 12 ft.	SC4		Non-Buffered Non-Brushed	39.84	38.25	37.45	36.65	35.06
				Buffered or Brushed	51.92	49.84	48.80	47.77	45.69



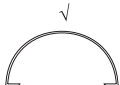
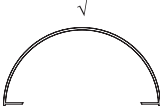

Part Number	Description	Cat. Page Ref.	View	Finish	Discount Quantity Pricing				
					1-5	6-10	11-24	25-99	100+
110134	Channel, Wireway, 12 ft.	SC4		Non-Buffered Non-Brushed	13.32	12.79	12.52	12.25	11.72
				Buffered or Brushed	18.66	17.91	17.54	17.17	16.42
110135	Reflector, Shell, 12 ft.	SC26		Non-Buffered Non-Brushed	43.62	41.88	41.00	40.13	38.39
				Buffered or Brushed	64.39	61.81	60.53	59.24	56.66
110137	Cover T with 1/4" Return, 12 ft.	SC15 HA32		Non-Buffered Non-Brushed	18.68	17.93	17.56	17.19	16.44
				Buffered or Brushed	20.85	20.02	19.60	19.18	18.35
110140	Heavy Duty Shoe, 12 ft. (works with Endcap Assembly 510241)	SC5 RD14		Non-Buffered Non-Brushed	30.43	29.21	28.60	28.00	26.78
				Buffered or Brushed	36.41	34.95	34.23	33.50	32.04
110141	135° Rear Vertical, 12 ft.			Non-Buffered Non-Brushed	141.77	136.10	133.26	130.43	124.76
				Buffered or Brushed	159.23	152.86	149.68	146.49	140.12
110142	135° Front Vertical, 12 ft.	SC8		Non-Buffered Non-Brushed	18.81	18.06	17.68	17.31	16.55
				Buffered or Brushed	24.32	23.35	22.86	22.37	21.40
110143	Rear Top Frame, Extended, 12 ft.			Non-Buffered Non-Brushed	30.54	29.32	28.71	28.10	26.88
				Buffered or Brushed	32.59	31.29	30.63	29.98	28.68
110144	Jamb, Upright, 12 ft.	SC4		Non-Buffered Non-Brushed	18.07	17.35	16.99	16.62	15.90
				Buffered or Brushed	22.69	21.78	21.33	20.87	19.97
110145	Cover Channel, 12 ft.			Non-Buffered Non-Brushed	21.24	20.39	19.97	19.54	18.69
				Buffered or Brushed	26.63	25.56	25.03	24.50	23.43
110146	Security Top Channel, 12 ft.	SC4		Non-Buffered Non-Brushed	20.04	19.24	18.84	18.44	17.64
				Buffered or Brushed	24.44	23.46	22.97	22.48	21.51
110147	Channel, 12 ft.	SC4		Non-Buffered Non-Brushed	16.22	15.57	15.25	14.92	14.27
				Buffered or Brushed	19.51	18.73	18.34	17.95	17.17

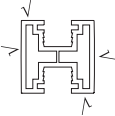



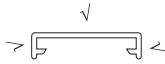
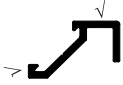
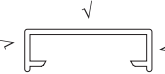
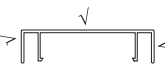
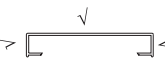

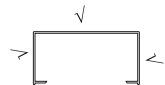

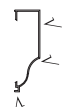

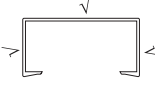
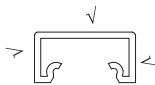

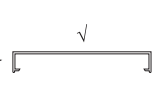

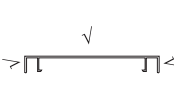

Part Number	Description	Cat. Page Ref.	View	Finish	Discount Quantity Pricing				
					1-5	6-10	11-24	25-99	100+
110150	1-1/2" x 1-1/2" x 1/8" Angle, 12 ft.	HA3		Non-Buffered Non-Brushed	47.51	45.61	44.66	43.71	41.81
				Buffered or Brushed	55.76	53.53	52.41	51.30	49.07
110153	Heavy Duty Molding, 12 ft.	S9 HA34		Non-Buffered Non-Brushed	41.14	39.49	38.67	37.85	36.20
				Buffered or Brushed	51.32	49.27	48.24	47.21	45.16
110156	Hinge Molding, 12 ft.	S8 HA34		Non-Buffered Non-Brushed	27.50	26.40	25.85	25.30	24.20
				Buffered or Brushed	32.74	31.43	30.78	30.12	28.81
110157	Glazing Strip, 12 ft.	SC8		Non-Buffered Non-Brushed	10.36	9.95	9.74	9.53	9.12
110159	1" x 1/2" x 1/16" Angle, 12 ft.	HA3		Non-Buffered Non-Brushed	13.93	13.37	13.09	12.82	12.26
				Buffered or Brushed	18.72	17.97	17.60	17.22	16.47
110160	2-1/2" x 1-3/4" Tube, 12 ft.	HA30		Non-Buffered Non-Brushed	115.45	110.83	108.52	106.21	101.60
				Buffered or Brushed	138.84	133.29	130.51	127.73	122.18
110162	1-3/16" Top Channel, 12 ft.	HA7 RD14		Non-Buffered Non-Brushed	24.27	23.30	22.81	22.33	21.36
				Buffered or Brushed	31.03	29.79	29.17	28.55	27.31
110164	Hinge Plate, 12 ft.	HA34		Non-Buffered Non-Brushed	10.41	9.99	9.79	9.58	9.16
				Buffered or Brushed	16.86	16.19	15.85	15.51	14.84
110165	1" x 1" x 1/16" Angle, 12 ft.	HA3		Non-Buffered Non-Brushed	18.33	17.60	17.23	16.86	16.13
				Buffered or Brushed	22.50	21.60	21.15	20.70	19.80
110166	1" x 1/8" Strip, 12 ft.	HA16		Non-Buffered Non-Brushed	18.59	17.85	17.47	17.10	16.36
				Buffered or Brushed	23.89	22.93	22.46	21.98	21.02
110167	2" x 2" X 1/8" Angle, 12 ft.	HA3		Non-Buffered Non-Brushed	65.61	62.99	61.67	60.36	57.74
				Buffered or Brushed	77.93	74.81	73.25	71.70	68.58

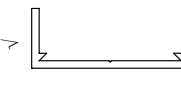

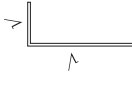
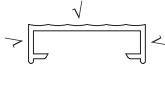



Part Number	Description	Cat. Page Ref.	View	Finish	Discount Quantity Pricing				
					1-5	6-10	11-24	25-99	100+
110168	1-1/2" x 3/4" x 1/8" Angle, 12 ft.	HA3		Non-Buffered Non-Brushed	35.27	33.86	33.15	32.45	31.04
				Buffered or Brushed	42.45	40.75	39.90	39.05	37.35
110171	1-1/4" x 3/32" Flat Bar, 12 ft.	HA16		Non-Buffered Non-Brushed	19.23	18.46	18.08	17.69	16.92
				Buffered or Brushed	24.03	23.07	22.59	22.11	21.15
110178	Security Track, 12 ft.	SC66 RD14		Non-Buffered Non-Brushed	30.32	29.11	28.50	27.89	26.68
				Buffered or Brushed	34.75	33.36	32.67	31.97	30.58
110180	5/8" x 7/16" x 1/16" Angle, 12 ft.	HA3 SC4		Non-Buffered Non-Brushed	12.25	11.76	11.52	11.27	10.78
				Buffered or Brushed	17.04	16.36	16.02	15.68	15.00
110181	135° Molding, 12 ft.	HA36		Non-Buffered Non-Brushed	44.52	42.74	41.85	40.96	39.18
				Buffered or Brushed	53.60	51.46	50.38	49.31	47.17
110182	1-1/4" x 3/8" x 1/16", Angle 12 ft.	HA3		Non-Buffered Non-Brushed	15.53	14.91	14.60	14.29	13.67
				Buffered or Brushed	22.06	21.18	20.74	20.30	19.41
110192	Front Frame with Lip, 12 ft.	SC15 HA32		Non-Buffered Non-Brushed	30.28	29.07	28.46	27.86	26.65
				Buffered or Brushed	35.18	33.77	33.07	32.37	30.96
110194	Cover Strip, 12 ft.	G16		Non-Buffered Non-Brushed	24.72	23.73	23.24	22.74	21.75
				Buffered or Brushed	25.80	24.77	24.25	23.74	22.70
110195	Security Top and Side Glass Support, 12 ft.	SC15 HA35		Non-Buffered Non-Brushed	34.19	32.82	32.14	31.45	30.09
				Buffered or Brushed	37.11	35.63	34.88	34.14	32.66
110196	Transparency Frame, 12 ft.	S11 HA33		Non-Buffered Non-Brushed	52.93	50.81	49.75	48.70	46.58
				Buffered or Brushed	60.62	58.20	56.98	55.77	53.35
110197	Z-Strip for 1/2" Panel, 12 ft.	HA33 S15		Non-Buffered Non-Brushed	23.63	22.68	22.21	21.74	20.79

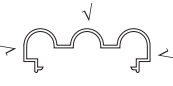
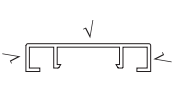

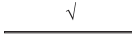

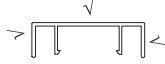

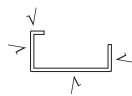
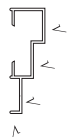
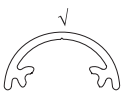
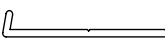
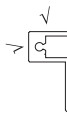

Part Number	Description	Cat. Page Ref.	View	Finish	Discount Quantity Pricing				
					1-5	6-10	11-24	25-99	100+
110198	Face Frame, 12 ft.	S15 HA33		Non-Buffered Non-Brushed	26.29	25.24	24.71	24.19	23.14
				Buffered or Brushed	29.07	27.91	27.33	26.74	25.58
110200	1-1/2" Diameter Half Round, 12 ft. (works with Endcap 310204 and Base 410443)	AT9		Non-Buffered Non-Brushed	28.18	27.05	26.49	25.93	24.80
				Buffered or Brushed	37.88	36.36	35.61	34.85	33.33
110201	2" Diameter Half Round, 12 ft. (works with Endcaps 310205 and Base 410443)	AT9		Non-Buffered Non-Brushed	33.89	32.53	31.86	31.18	29.82
				Buffered or Brushed	39.97	38.37	37.57	36.77	35.17
110202	3" Diameter Half Round, 12 ft. (works with Endcaps 310206, and Base 410540)	AT9		Non-Buffered Non-Brushed	62.57	60.07	58.82	57.56	55.06
				Buffered or Brushed	78.77	75.62	74.04	72.47	69.32
110204	Heavy Duty Hinge Plate, 12 ft.	HA34 S15		Non-Buffered Non-Brushed	23.01	22.09	21.63	21.17	20.25
				Buffered or Brushed	27.78	26.67	26.11	25.56	24.45
110208	Security Track, 12 ft.	RD14		Non-Buffered Non-Brushed	38.59	37.05	36.27	35.50	33.96
				Buffered or Brushed	46.47	44.61	43.68	42.75	40.89
110210	4" Diameter Half Round, 12 ft. (works with Endcap 310207 and Base 410458)	AT10		Non-Buffered Non-Brushed	80.09	76.89	75.28	73.68	70.48
				Buffered or Brushed	101.14	97.09	95.07	93.05	89.00
110212	6" Diameter Half Round, 12 ft. (works with Endcap 310209 and Base 412002)	AT10		Non-Buffered Non-Brushed	132.29	127.00	124.35	121.71	116.42
				Buffered or Brushed	161.85	155.38	152.14	148.90	142.43
110214	Crown Wall Trim, 12 ft. (works with LH Endcap 310211, RH Endcap 310210, and Base 410458)	AT14		Non-Buffered Non-Brushed	79.68	76.49	74.90	73.31	70.12
				Buffered or Brushed	83.39	80.05	78.39	76.72	73.38
110215	2-Way 180° Vertical, 12 ft.	G16		Non-Buffered Non-Brushed	196.94	189.06	185.12	181.18	173.31
				Buffered or Brushed	205.28	197.07	192.96	188.86	180.65
110216	Door Stop Jamb, 12 ft.	HA32		Non-Buffered Non-Brushed	20.19	19.38	18.98	18.57	17.77
				Buffered or Brushed	27.33	26.24	25.69	25.14	24.05

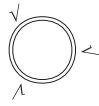
Part Number	Description	Cat. Page Ref.	View	Finish	Discount Quantity Pricing				
					1-5	6-10	11-24	25-99	100+
110220	Face Frame Mullion, 12 ft.	S14 HA32		Non-Buffered Non-Brushed	90.25	86.64	84.84	83.03	79.42
				Buffered or Brushed	94.61	90.83	88.93	87.04	83.26
110223	1-3/8" x 21/64" Rectangular Trim, 12 ft. (works with Endcap 310212 and Base 410443)	AT11		Non-Buffered Non-Brushed	23.34	22.41	21.94	21.47	20.54
				Buffered or Brushed	33.84	32.49	31.81	31.13	29.78
110224	Glazing, Jamb, without leg, 12 ft.	S10		Non-Buffered Non-Brushed	14.54	13.96	13.67	13.38	12.80
				Buffered or Brushed	18.12	17.40	17.03	16.67	15.95
110225	1-1/2" x 1/2" Rectangular Trim, 12 ft. (works with Endcap 310213 and Base 410443)	AT11		Non-Buffered Non-Brushed	29.27	28.10	27.51	26.93	25.76
				Buffered or Brushed	38.91	37.35	36.58	35.80	34.24
110226	3" x 3/4" Rectangular Trim, 12 ft. (works with Endcap 310214 and Base 410540)	AT11		Non-Buffered Non-Brushed	59.63	57.24	56.05	54.86	52.47
				Buffered or Brushed	77.84	74.73	73.17	71.61	68.50
110227	4" x 3/4" Rectangular Trim, 12 ft. (works with Endcap 310215 and Base 412272)	AT11		Non-Buffered Non-Brushed	76.25	73.20	71.68	70.15	67.10
				Buffered or Brushed	102.09	98.01	95.96	93.92	89.84
110228	Front Frame Molding, 12 ft.	HA32		Non-Buffered Non-Brushed	14.47	13.89	13.60	13.31	12.73
				Buffered or Brushed	22.02	21.14	20.70	20.26	19.38
110229	3-1/2" x 1/8" Rectangular Bar, 12 ft.	HA16		Non-Buffered Non-Brushed	60.77	58.34	57.12	55.91	53.48
				Buffered or Brushed	71.54	68.68	67.25	65.82	62.96
110232	4" x 2" Rectangular Trim, 12 ft. (works with Endcap 310218 and Base 410458)	AT11		Non-Buffered Non-Brushed	75.48	72.46	70.95	69.44	66.42
				Buffered or Brushed	86.50	83.04	81.31	79.58	76.12
110233	1-3/8" Inside Cove, 12 ft. (works with Endcap 310219 and Base 410443)	AT14		Non-Buffered Non-Brushed	54.19	52.02	50.94	49.85	33.52
				Buffered or Brushed	58.72	56.37	55.20	54.02	37.51
110234	4" Cornice Trim, 12 ft. (works with LH Endcap 310221, RH Endcap 310220 and Base 410458)	AT14		Non-Buffered Non-Brushed	69.72	66.93	65.54	64.14	61.35
				Buffered or Brushed	80.05	76.85	75.25	73.65	70.44





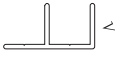
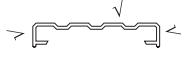

Part Number	Description	Cat. Page Ref.	View	Finish	Discount Quantity Pricing				
					1-5	6-10	11-24	25-99	100+
110244	4-1/2" x 1-1/2" Stepped Trim, 12 ft. (works with LH Endcap 310228, RH Endcap 310227 and Base 410458)	AT14		Non-Buffered Non-Brushed	86.01	82.57	80.85	79.13	75.69
				Buffered or Brushed	103.33	99.20	97.13	95.06	90.93
110245	3" x 1.5" Rectangular Trim, 12 ft. (works with Endcap 310229 and Base 410540)	AT11		Non-Buffered Non-Brushed	112.89	108.37	106.12	68.18	64.78
				Buffered or Brushed	126.74	121.67	119.14	80.37	76.36
110248	1" X 1/2" Rectangular Trim, 12 ft. (works with Base 411331)	AT11		Non-Buffered Non-Brushed	26.26	25.21	24.68	24.16	23.11
				Buffered or Brushed	35.65	34.22	33.51	32.80	31.37
110251	Shoe Filler, 12 ft.	RD14 HA10		Non-Buffered Non-Brushed	6.32	6.07	5.94	5.81	5.56
				Buffered or Brushed	7.28	6.99	6.84	6.70	6.41
110258	Pull, 12 ft.	HA23		Non-Buffered Non-Brushed	63.59	61.05	59.77	58.50	55.96
				Buffered or Brushed	74.37	71.40	69.91	68.42	65.45
110260	5" x 3/4" Rectangular Trim, 12 ft. (works with Endcap 310233 and Base 412002)	AT13		Non-Buffered Non-Brushed	70.15	67.34	65.94	64.54	61.73
				Buffered or Brushed	91.53	87.87	86.04	84.21	80.55
110267	3/4" Diameter Half Round, 12 ft. (works with Endcap 310395 and Base 411331)	AT9		Non-Buffered Non-Brushed	10.55	10.13	9.92	9.71	9.28
				Buffered or Brushed	14.05	13.49	13.21	12.93	12.36
110268	Z-Strip for 1/4" Panel, 12 ft.	HA33 S11		Non-Buffered Non-Brushed	18.17	17.44	17.08	16.72	15.99
110269	6" x 3/4" Rectangular Trim, 12 ft. (works with Endcap 310235 and Base 412002)	AT11		Non-Buffered Non-Brushed	112.59	108.09	105.83	103.58	99.08
				Buffered or Brushed	155.83	149.60	146.48	143.36	137.13
110286	3" Radius Quarter Round, 12 ft. (works with LH Endcap 310242, RH Endcap 310239 and Base 410540)	AT66		Non-Buffered Non-Brushed	76.45	73.39	71.86	70.33	67.28
				Buffered or Brushed	91.62	87.96	86.12	84.29	80.63



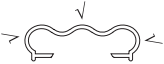

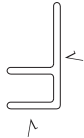
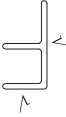
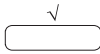
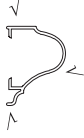

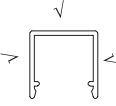

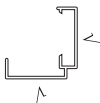

Part Number	Description	Cat. Page Ref.	View	Finish	Discount Quantity Pricing				
					1-5	6-10	11-24	25-99	100+
110289	Bottom Frame, Low Profile, 12 ft.	SC5		Non-Buffered Non-Brushed	19.33	18.56	18.17	17.78	17.01
				Buffered or Brushed	23.98	23.02	22.54	22.06	22.10
110290	1-1/2" Radius Quarter Round, 12 ft. (works with LH Endcap 310243, RH Endcap 310240, and base 410443)	AT6		Non-Buffered Non-Brushed	44.49	42.71	41.82	40.93	39.15
				Buffered or Brushed	54.24	52.07	50.99	49.90	47.73
110293	2-1/2" x 1" Angle, 12 ft.	HA3		Non-Buffered Non-Brushed	39.30	37.73	36.94	36.16	34.58
				Buffered or Brushed	51.65	49.58	48.55	47.52	45.45
110294	1-1/2" x 1/2" Scalloped Rectangular, 12 ft. (works with Endcap 310241 and Base 410443)	AT11		Non-Buffered Non-Brushed	27.34	26.25	25.70	25.15	24.06
				Buffered or Brushed	35.87	34.44	33.72	33.00	31.57
110295	2" Half Round with 3/4" Returns, 12 ft. (works with Endcap 310205 and Base 410443)	AT6		Non-Buffered Non-Brushed	46.15	44.30	43.38	42.46	40.61
				Buffered or Brushed	60.25	57.84	56.64	55.43	53.02
110296	3/4" Radius Quarter Round, 12 ft. (works with LH Endcap 310374, RH Endcap 310375 and Base 411331)	AT11		Non-Buffered Non-Brushed	15.77	15.14	14.82	14.51	13.88
				Buffered or Brushed	20.49	19.67	19.26	18.85	18.03
110298	1-1/2" Tee, 12 ft.	HA27		Non-Buffered Non-Brushed	44.54	42.76	41.87	40.98	39.20
				Buffered or Brushed	56.20	53.95	52.83	51.70	49.46
110299	1-1/4" Radius Quarter Round, 12 ft. (works with LH Endcap 310245, RH Endcap 310244 and Base 410530)	AT6		Non-Buffered Non-Brushed	37.14	35.65	34.91	34.17	32.68
				Buffered or Brushed	51.90	49.82	48.79	47.75	45.67
110300	Extended Face Frame, 12 ft.	S11 HA33		Non-Buffered Non-Brushed	41.85	40.18	39.34	38.50	36.83
				Buffered or Brushed	50.10	48.10	47.09	46.09	44.09
110301	2-7/8" Fluted Trim, 12 ft. (works with Endcap 310246 and Base 410540)	AT14		Non-Buffered Non-Brushed	63.09	60.57	59.30	58.04	55.52
				Buffered or Brushed	81.19	77.94	76.32	74.69	71.45
110304	2-1/4" x 1/2" Rectangular Trim, 12 ft. (work with Endcap 310251 and Base 410443)	AT11		Non-Buffered Non-Brushed	47.20	45.31	44.37	43.42	41.54
				Buffered or Brushed	64.55	61.97	60.68	59.39	56.80

Part Number	Description	Cat. Page Ref.	View	Finish	Discount Quantity Pricing				
					1-5	6-10	11-24	25-99	100+
110305	7" x 1/16" Trim Strip, 8 ft.	HA16		Non-Buffered Non-Brushed	57.95	55.63	54.47	53.31	51.00
				Buffered or Brushed	70.94	68.10	66.68	65.26	62.43
110306	1-1/2" x 1-1/2" x 1/8" 135° Angle, 12 ft.	HA3		Non-Buffered Non-Brushed	52.51	50.41	49.36	48.31	46.21
				Buffered or Brushed	67.95	65.23	63.87	62.51	59.80
110307	2" x 5/8" Rectangular Trim, 12 ft. (works with Endcap 310250 and Base 410443)	AT11		Non-Buffered Non-Brushed	43.05	41.33	40.47	39.61	37.88
				Buffered or Brushed	58.46	56.12	54.95	53.78	51.44
110308	2" Radius Quarter Round, 12 ft. (works with LH Endcap 310253, RH Endcap 310252 and Base 410443)	AT6		Non-Buffered Non-Brushed	94.89	91.09	89.20	57.54	54.66
				Buffered or Brushed	101.00	96.96	94.94	62.92	59.77
110309	2-1/2" Radius Quarter Round, 12 ft. (works with LH Endcap 310255, RH Endcap 310254 and Base 410540)	AT6		Non-Buffered Non-Brushed	99.73	95.74	93.75	60.29	57.27
				Buffered or Brushed	106.38	102.12	100.00	66.13	62.83
110310	2-1/2" Diameter Half Round, 12 ft. (works with Endcap 310249 and Base 410540)	AT8		Non-Buffered Non-Brushed	63.85	61.30	60.02	58.74	38.88
				Buffered or Brushed	72.06	69.18	67.74	66.30	46.10
110315	1-1/2" Front Frame for Curving, 12 ft.			Non-Buffered Non-Brushed	47.39	45.49	44.55	43.60	29.72
				Buffered or Brushed	56.87	54.60	53.46	52.32	38.07
110325	3" x 1" Stepped Trim, 12 ft. (works with LH Endcap 310259, RH Endcap 310260 and Base 410443)	AT14		Non-Buffered Non-Brushed	103.42	99.28	97.21	63.51	60.34
				Buffered or Brushed	114.27	109.70	107.41	73.06	69.41
110328	1" Diameter Half Round, 12 ft. (works with Endcap 310323 and Base 411331)	AT8		Non-Buffered Non-Brushed	18.55	17.81	17.44	17.07	16.32
				Buffered or Brushed	27.66	26.55	26.00	25.45	24.34
110340	Reflector Strip, 12 ft.			Non-Buffered Non-Brushed	17.88	17.16	16.81	16.45	15.73
110341	Edge Molding with Leg, 12 ft.	S13 HA34		Non-Buffered Non-Brushed	25.92	24.88	24.36	23.85	22.81
				Buffered or Brushed	35.70	34.27	33.56	32.84	31.42



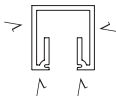

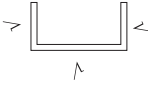

Part Number	Description	Cat. Page Ref.	View	Finish	Discount Quantity Pricing				
					1-5	6-10	11-24	25-99	100+
110346	Frame Clip, 12 ft.	HA33		Non-Buffered Non-Brushed	23.32	22.39	21.92	21.45	20.52
110348	13/16" I.D. Tube, .050" Thick, 12 ft. (.913 O.D.)	HA29		Non-Buffered Non-Brushed	23.45	22.51	22.04	21.57	20.64
				Buffered or Brushed	34.06	32.70	32.02	31.34	29.97
110350	Heavy Duty Shoe, 12 ft. (works with Endcap Assembly 510331)	SC9 RD10		Non-Buffered Non-Brushed	45.62	43.80	42.88	41.97	40.15
				Buffered or Brushed	55.34	53.13	52.02	50.91	48.70
110358	Anchor Channel for 2" WallMaker Sills, 12 ft.	G2		Non-Buffered Non-Brushed	56.95	54.67	53.53	52.39	50.12
110359	1"x2" WallMaker Flanged Header, smooth, 12 ft.	G10 HA10		Non-Buffered Non-Brushed	91.19	87.54	85.72	83.89	80.25
				Buffered or Brushed	103.81	99.66	97.58	95.51	91.35
110360	1"x2" WallMaker Header, smooth, 12 ft.	G10 HA11		Non-Buffered Non-Brushed	59.78	57.39	56.19	55.00	52.61
				Buffered or Brushed	80.55	77.33	75.72	74.11	70.88
110361	1"x1" WallMaker Sill, 12 ft.	G7 HA10		Non-Buffered Non-Brushed	36.20	34.75	34.03	33.30	31.86
				Buffered or Brushed	47.55	45.65	44.70	43.75	41.84
110372	Single Channel with Extended Leg, 12 ft.	RD14 HA35		Non-Buffered Non-Brushed	21.31	20.46	20.03	19.61	18.75
				Buffered or Brushed	26.67	25.60	25.07	24.54	23.47
110381	2-5/8" x 1/2" Streamline, 12 ft. (works with Endcap 310286 and Base 410540)	AT14		Non-Buffered Non-Brushed	69.53	66.75	65.36	63.97	43.88
				Buffered or Brushed	81.82	78.55	76.91	75.27	54.69
110382	2-5/8" x 1-3/4" Classic Cornice, 12 ft. (works with RH Endcap 310288, LH Endcap 310287 and Base 410540)	AT14		Non-Buffered Non-Brushed	46.32	44.47	43.54	42.61	40.76
				Buffered or Brushed	75.20	72.19	70.69	69.18	66.18
110383	3" x 2-1/2" Classic Cove, 12 ft. (works with LH Endcap 310292, RH Endcap 310293 and Base 410540)	AT15		Non-Buffered Non-Brushed	94.80	91.01	89.11	87.22	83.42
				Buffered or Brushed	97.27	93.38	91.43	89.49	85.60



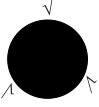

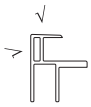

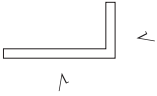
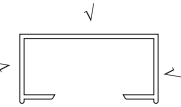
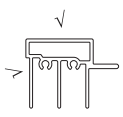
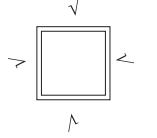

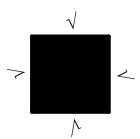

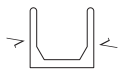

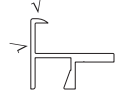
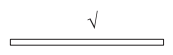
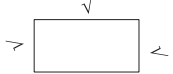
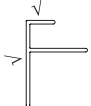

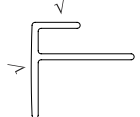
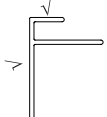
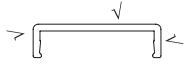
Part Number	Description	Cat. Page Ref.	View	Finish	Discount Quantity Pricing				
					1-5	6-10	11-24	25-99	100+
110384	2" x 5/8" New Wave, 12 ft. (works with Endcap 310289 and Base 410443)	AT15		Non-Buffered Non-Brushed	55.34	53.13	52.02	50.91	33.11
				Buffered or Brushed	63.99	61.43	60.15	58.87	40.73
110385	2-3/16" x 1/2" Classic Trim, 12 ft. (works with LH Endcap 310290, RH Endcap 310291 and Base 410443)	AT15		Non-Buffered Non-Brushed	31.32	30.07	29.44	28.81	27.56
				Buffered or Brushed	39.85	38.26	37.46	36.66	35.07
110391	Accent Strip for Curved Lengths, 12 ft.	HA16		Non-Buffered Non-Brushed	7.24	6.95	6.81	6.66	6.37
				Buffered or Brushed	11.04	10.60	10.38	10.16	9.72
110394	1/4" Glass Shelf Edging, 12 ft.	HA35		Non-Buffered Non-Brushed	20.62	19.80	19.38	18.97	18.15
				Buffered or Brushed	25.02	24.02	23.52	23.02	22.02
110395	3/8" Glass Shelf Edging, 12 ft.	HA35		Non-Buffered Non-Brushed	19.00	18.24	17.86	17.48	16.72
				Buffered or Brushed	25.48	24.45	23.95	23.44	22.42
110398	Accent Strip for Straight Lengths, 12 ft.	HA16		Non-Buffered Non-Brushed	13.49	12.95	12.68	12.41	11.87
				Buffered or Brushed	18.66	17.91	17.54	17.17	16.42
110400	2" x 1-1/2" Panel Molding, 12 ft. (works with LH Endcap 310386, RH Endcap 310385 and Base 410443)	AT15		Non-Buffered Non-Brushed	47.64	45.73	44.78	43.83	41.92
				Buffered or Brushed	52.11	50.03	48.98	47.94	45.86
110403	3/8" Face Frame, 12 ft.	HA33 S8		Non-Buffered Non-Brushed	25.55	24.53	24.02	23.51	22.48
				Buffered or Brushed	30.89	29.65	29.04	28.42	27.18
110410	3/4" Square Trim, 12 ft. (works with Endcap 310403 and Base 411331)	AT11		Non-Buffered Non-Brushed	29.47	28.29	27.70	27.11	25.93
				Buffered or Brushed	34.04	32.68	32.00	31.32	29.96
110412	Deep Pocket Shoe, 12 ft. (works with Endcap Assembly 510371)	RD14		Non-Buffered Non-Brushed	42.38	40.68	39.84	38.99	37.29
				Buffered or Brushed	59.10	56.74	55.55	54.37	52.01
110413	3/4" x 4" Channel, 12 ft.	HA11		Non-Buffered Non-Brushed	158.49	152.15	148.98	145.81	139.47
				Buffered or Brushed	169.45	162.67	159.28	155.89	149.12



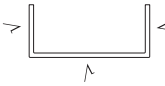
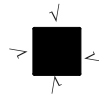

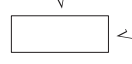

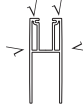
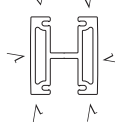
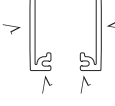
Part Number	Description	Cat. Page Ref.	View	Finish	Discount Quantity Pricing				
					1-5	6-10	11-24	25-99	100+
110419	3" x 1/8" Bar, 12 ft.	HA16		Non-Buffered Non-Brushed	57.36	55.07	53.92	52.77	50.48
				Buffered or Brushed	66.09	63.45	62.12	60.80	58.16
110420	3" X 1" Radius Step Trim, 12 ft. (works with LH endcap 310378, RH endcap 310377 and base 410540)	AT15		Non-Buffered Non-Brushed	78.69	75.54	73.97	48.93	46.48
				Buffered or Brushed	89.04	85.48	83.70	58.04	55.13
110423	1/2" O.D. Tube, 5/64" thick, 12 ft.	HA29		Non-Buffered Non-Brushed	18.85	18.10	17.72	17.34	16.59
				Buffered or Brushed	19.74	18.95	18.56	18.16	17.37
110424	1-1/2" x 1-1/2" Corner Trim, 12 ft. (Works with base 410443)	AT15		Non-Buffered Non-Brushed	51.57	49.51	48.48	47.44	45.38
				Buffered or Brushed	56.24	53.99	52.87	51.74	49.49
110426	Glass End Stock Endcap Extrusion, 8 ft.	HA36		Non-Buffered Non-Brushed	47.60	45.70	44.74	43.79	41.89
				Buffered or Brushed	53.78	51.63	50.55	49.48	47.33
110428	Anchor Channel for 2-1/2" WallMaker Sills, 12 ft.	G6		Non-Buffered Non-Brushed	70.21	67.40	66.00	64.59	61.78
110432	1" Diameter Half Round with 3/8" Channel, 12 ft. (works with Endcaps LH 310324 and RH 310325)	HA35		Non-Buffered Non-Brushed	35.83	34.40	33.68	32.96	31.53
				Buffered or Brushed	37.43	35.93	35.18	34.44	32.94
110434	2-9/16"x2-1/2" WallMaker Header, 12 ft.	G12		Non-Buffered Non-Brushed	207.00	198.72	194.58	190.44	182.16
				Buffered or Brushed	224.58	215.60	211.11	206.61	197.63
110441	1/4" Trim Channel, 12 ft.	SC5		Non-Buffered Non-Brushed	15.61	14.99	14.67	14.36	13.74
				Buffered or Brushed	23.91	22.95	22.48	22.00	21.04
110451	7/8" x 7/8" x 1/16" Angle, 12 ft.	HA3		Non-Buffered Non-Brushed	17.65	16.94	16.59	16.24	15.53
				Buffered or Brushed	24.70	23.71	23.22	22.72	21.74
110461	2" x 1" Channel, 12 ft.	HA10		Non-Buffered Non-Brushed	53.98	51.82	50.74	49.66	47.50
				Buffered or Brushed	63.52	60.98	59.71	58.44	55.90
110465	5-3/4" x 2-1/4" Traditional American, 12 ft. (works with LH Endcap 310399 RH Endcap 310400 and Base 412002)	AT15		Non-Buffered Non-Brushed	131.08	125.84	123.22	120.59	115.35
				Buffered or Brushed	185.73	178.30	174.59	170.87	163.44

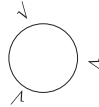
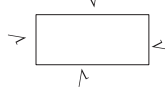
Part Number	Description	Cat. Page Ref.	View	Finish	Discount Quantity Pricing				
					1-5	6-10	11-24	25-99	100+
110471	Upright, Center, 12 ft.			Non-Buffered Non-Brushed	28.79	27.64	27.06	26.49	25.34
110472	Upright, Wall, 12 ft.			Non-Buffered Non-Brushed	88.76	85.21	83.43	81.66	78.11
				Buffered or Brushed	99.44	95.46	93.47	91.48	87.51
110481	2"x6" WallMaker Sill, 12 ft.	G10		Non-Buffered Non-Brushed	392.00	376.32	368.48	360.64	344.96
				Buffered or Brushed	425.79	408.76	400.24	391.73	374.70
110482	2"x4" WallMaker Sill, 12 ft.	G9		Non-Buffered Non-Brushed	272.26	261.37	255.92	250.48	239.59
				Buffered or Brushed	298.88	286.92	280.95	274.97	263.01
110483	2"x1-3/4" WallMaker Header, 12 ft.	G9		Non-Buffered Non-Brushed	107.72	103.41	101.26	99.10	94.79
				Buffered or Brushed	123.84	118.89	116.41	113.93	108.98
110507	1-1/4" Dia. Half Round with 1/2" Return, 12 ft. (works with Base 410530 and Recessed Base 411185)	AT8		Non-Buffered Non-Brushed	29.20	28.03	27.45	26.86	25.70
				Buffered or Brushed	36.27	34.82	34.09	33.37	31.92
110521	Filler Strip, 12 ft.	G3		Non-Buffered Non-Brushed	11.96	11.48	11.24	11.00	10.52
				Buffered or Brushed	15.39	14.77	14.47	14.16	13.54
110523	Backframe Header without Top Glass, 12 ft.	SC15		Non-Buffered Non-Brushed	73.95	70.99	69.51	68.03	65.08
				Buffered or Brushed	85.18	81.77	80.07	78.37	74.96
110538	1-21/32" x 1/8" Flat Stock, 12 ft. (0.10 crown on surface opposite groove)	HA16		Non-Buffered Non-Brushed	33.60	32.26	31.58	30.91	29.57
				Buffered or Brushed	41.42	39.76	38.93	38.11	36.45
110547	Cover, Smooth, Inside "H", 12 ft.			Non-Buffered Non-Brushed	49.37	47.40	46.41	45.42	43.45
				Buffered or Brushed	53.23	51.10	50.04	48.97	46.84
110548	Cover, Smooth, Outside "H", 12 ft.			Non-Buffered Non-Brushed	35.36	33.95	33.24	32.53	31.12
				Buffered or Brushed	41.03	39.39	38.57	37.75	36.11
110560	Rod, 3/4" Dia., 12 ft.	HA29		Non-Buffered Non-Brushed	63.01	60.49	59.23	57.97	55.45
				Buffered or Brushed	68.68	65.93	64.56	63.19	60.44

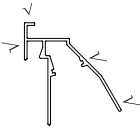
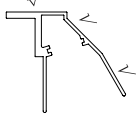
Part Number	Description	Cat. Page Ref.	View	Finish	Discount Quantity Pricing				
					1-5	6-10	11-24	25-99	100+
110563	Rod, 2" Dia., 12 ft.	HA29		Non-Buffered Non-Brushed	403.73	387.58	379.51	371.43	355.28
				Buffered or Brushed	409.67	393.28	385.09	376.90	360.51
110573	Wireway Tube, 12 ft.	HA30		Non-Buffered Non-Brushed	12.88	12.36	12.11	11.85	11.33
				Buffered or Brushed	16.00	15.36	15.04	14.72	14.08
110577	Showcase Molding w/o Holes, 12 ft. (with holes 410099)	SC15 HA10		Non-Buffered Non-Brushed	12.42	11.92	11.67	11.43	10.93
				Buffered or Brushed	16.65	15.98	15.65	15.32	14.65
110582	Showcase Rail, 12 ft.	SC15		Non-Buffered Non-Brushed	46.94	45.06	44.12	43.18	41.31
				Buffered or Brushed	49.25	47.28	46.30	45.31	43.34
110617	Sign Trim, 12 ft. (works with Base 110618)	AT15		Non-Buffered Non-Brushed	28.70	27.55	26.98	26.40	25.26
				Buffered or Brushed	36.13	34.68	33.96	33.24	31.79
110618	Sign Trim Base, 12 ft. (works with Trim 110617)	AT16		Non-Buffered Non-Brushed	18.81	18.06	17.68	17.31	16.55
110622	3/4" x 1-1/2" x 1/8" Angle, 84"	HA4		Non-Buffered Non-Brushed	25.53	24.51	24.00	23.49	22.47
				Buffered or Brushed	30.93	29.69	29.07	28.46	27.22
110639	1" x 2" x 1" Rectangular Trim, 12 ft. (works with Base 410443, 410466) (works with endcap 310735)	AT11		Non-Buffered Non-Brushed	42.40	40.70	39.86	39.01	37.31
				Buffered or Brushed	54.63	52.44	51.35	50.26	48.07
110640	Top Rear Showcase Channel, for 1/2" Glass, 12 ft.	SC15		Non-Buffered Non-Brushed	74.46	71.48	69.99	68.50	65.52
				Buffered or Brushed	92.34	88.65	86.80	84.95	81.26
110641	2" Square Tube, 1/8" Thick, 12 ft.	HA30		Non-Buffered Non-Brushed	131.47	126.21	123.58	120.95	115.69
				Buffered or Brushed	141.39	135.73	132.91	130.08	124.42
110646	Trim, Drawer, 12 ft.			Non-Buffered Non-Brushed	13.44	12.90	12.63	12.36	11.83
110648	Bar, 1" x 1", 12 ft.	HA16		Non-Buffered Non-Brushed	136.01	130.57	127.85	125.13	119.69
				Buffered or Brushed	143.46	137.72	134.85	131.98	126.24

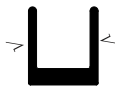
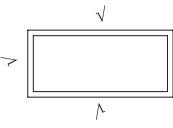
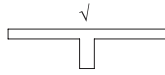

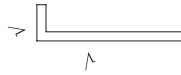

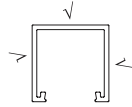

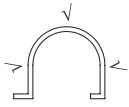
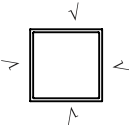
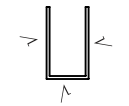
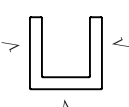
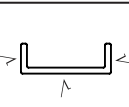
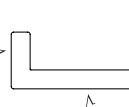
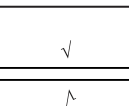
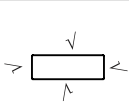
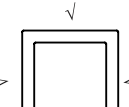
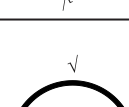
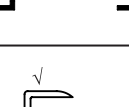

Part Number	Description	Cat. Page Ref.	View	Finish	Discount Quantity Pricing				
					1-5	6-10	11-24	25-99	100+
110649	Security Channel for 3/8" Glass, 12 ft.	SC12		Non-Buffered Non-Brushed	20.90	20.06	19.65	19.23	18.39
				Buffered or Brushed	22.47	21.57	21.12	20.67	19.77
110650	3/8" Glass Channel, 12 ft.	HA10 SC15		Non-Buffered Non-Brushed	14.97	14.37	14.07	13.77	13.17
				Buffered or Brushed	17.46	16.76	16.41	16.06	15.36
110652	F Channel, 3/8" Glass 12 ft.			Non-Buffered Non-Brushed	23.52	22.58	22.11	21.64	20.70
				Buffered or Brushed	31.46	30.20	29.57	28.94	27.68
110653	Front Frame with Security Lip for 3/8" Glass, 12 ft.	SC15		Non-Buffered Non-Brushed	32.74	31.43	30.78	30.12	28.81
				Buffered or Brushed	38.08	36.56	35.80	35.03	33.51
110655	6-1/2" x 1/4" Bar, 10 ft.	HA11		Non-Buffered Non-Brushed	166.76	160.09	156.75	153.42	146.75
				Buffered or Brushed	180.51	173.29	169.68	166.07	158.85
110665	1/2" x 1/4" Rectangular Bar, 12 ft.	HA16		Non-Buffered Non-Brushed	28.02	26.90	26.34	25.78	24.66
				Buffered or Brushed	35.22	33.81	33.11	32.40	30.99
110666	3/8" Glass "F" Channel, 12 ft.			Non-Buffered Non-Brushed	26.86	25.79	25.25	24.71	23.64
				Buffered or Brushed	34.69	33.30	32.61	31.91	30.53
110669	3/4" Column Molding, 12 ft.	FM17		Non-Buffered Non-Brushed	95.16	91.35	89.45	87.55	83.74
				Buffered or Brushed	104.10	99.94	97.85	95.77	91.61
110670	1/4" Glass Shelf Edging, 12 ft.			Non-Buffered Non-Brushed	29.51	28.33	27.74	27.15	25.97
				Buffered or Brushed	32.61	31.31	30.65	30.00	28.70
110671	1/4" Glass "F" Channel with Unequal Legs, 12 ft.			Non-Buffered Non-Brushed	28.09	26.97	26.40	25.84	24.72
				Buffered or Brushed	33.83	32.48	31.80	31.12	29.77
110672	3/4" Trim (works with Base 412007), 12 ft.	AT11		Non-Buffered Non-Brushed	11.31	10.86	10.63	10.41	9.95
				Buffered or Brushed	13.91	13.35	13.08	12.80	12.24
110674	Shelf Sign Holder, 12 ft.	HA33		Non-Buffered Non-Brushed	31.94	30.66	30.02	29.38	28.11
				Buffered or Brushed	35.84	34.41	33.69	32.97	31.54

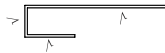
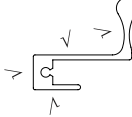
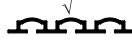



Part Number	Description	Cat. Page Ref.	View	Finish	Discount Quantity Pricing				
					1-5	6-10	11-24	25-99	100+
110683	1-23/32" x 3/4" U-Channel, 10 ft.	HA10		Non-Buffered Non-Brushed	26.06	25.02	24.50	23.98	22.93
				Buffered or Brushed	34.13	32.76	32.08	31.40	30.03
110689	1/2" x 1/2" Bar Sq., 12 ft.	HA16		Non-Buffered Non-Brushed	35.46	34.04	33.33	32.62	31.20
				Buffered or Brushed	38.57	37.03	36.26	35.48	33.94
110691	U-Channel with Returns, 12 ft.	HA10		Non-Buffered Non-Brushed	18.78	18.03	17.65	17.28	16.53
110693	1/2" x 3/16" Flat Bar, 12 ft.	HA16		Non-Buffered Non-Brushed	16.84	16.17	15.83	15.49	14.82
				Buffered or Brushed	18.02	17.30	16.94	16.58	15.86
110697	1-1/2" x 1-1/4" Anchor Channel, 10 ft.	G15		Non-Buffered Non-Brushed	50.16	48.15	47.15	46.15	44.14
110698	1-1/2" x 4" Sill, 10 ft.	G15		Non-Buffered Non-Brushed	196.98	189.10	185.16	181.22	173.34
				Buffered or Brushed	213.81	205.26	200.98	196.71	188.15
110699	1-1/2" x 1-3/4" H Channel, 10 ft.	G16		Non-Buffered Non-Brushed	133.68	128.33	125.66	122.99	117.64
				Buffered or Brushed	158.62	152.28	149.10	145.93	139.59
110700	1-1/2" x 1-3/4" Top Channel, 10 ft.	G16		Non-Buffered Non-Brushed	74.84	71.85	70.35	68.85	65.86
				Buffered or Brushed	85.43	82.01	80.30	78.60	75.18
110705	5/8" X 3/4" x 1/16" Tube, 8 ft.	HA30		Non-Buffered Non-Brushed	17.81	17.10	16.74	16.39	15.67
				Buffered or Brushed	26.16	25.11	24.59	24.07	23.02
110706	1-1/8" Diameter Rod, 12 ft.	HA29		Non-Buffered Non-Brushed	139.55	133.97	131.18	128.39	122.80
				Buffered or Brushed	146.02	140.18	137.26	134.34	128.50
110709	1-1/3" x 1/2" Rectangular Bar, 12 ft.	HA16		Non-Buffered Non-Brushed	93.58	89.84	87.97	86.09	82.35
				Buffered or Brushed	103.26	99.13	97.06	95.00	90.87

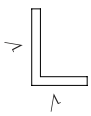

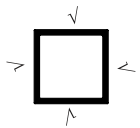

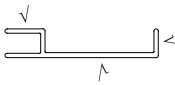
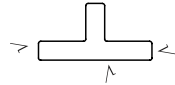
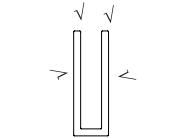
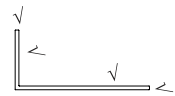
Part Number	Description	Cat. Page Ref.	View	Finish	Discount Quantity Pricing				
					1-5	6-10	11-24	25-99	100+
110719	Reflector Shell, 30° Opening with Security Glass Lip, 12 ft.	SC17		Non-Buffered Non-Brushed	68.35	65.62	64.25	62.88	60.15
				Buffered or Brushed	73.88	70.92	69.45	67.97	65.01
110720	Reflector Shell, 30° Opening without Security Glass Lip, 12 ft.	SC17		Non-Buffered Non-Brushed	75.58	72.56	71.05	69.53	66.51
				Buffered or Brushed	90.45	86.83	85.02	83.21	79.60
110725	U Channel 3/8" Glass with Extended Leg, 12 ft.			Non-Buffered Non-Brushed	23.62	22.68	22.20	21.73	20.79
				Buffered or Brushed	27.54	26.44	25.89	25.34	24.24
110728	1-17/32" x 9/16" Angle, 12 ft.	HA3		Non-Buffered Non-Brushed	22.96	22.04	21.58	21.12	20.20
				Buffered or Brushed	26.38	25.32	24.80	24.27	23.21
110730	Channel 3/8" Glass, 12 ft.	HA11		Non-Buffered Non-Brushed	31.52	30.26	29.63	29.00	19.23
				Buffered or Brushed	34.34	32.97	32.28	31.59	21.72
110731	Tube, 1-5/8" x 3/4" Rectangle, 12 ft.	HA30		Non-Buffered Non-Brushed	46.62	44.76	43.82	42.89	41.03
				Buffered or Brushed	58.88	56.52	55.35	54.17	51.81
110734	Tee, 2" x 1/2", 10 ft.	HA27		Non-Buffered Non-Brushed	40.53	38.91	38.10	37.29	35.67
				Buffered or Brushed	43.36	41.63	40.76	39.89	38.16
110735	Tee, 3/4" x 1/2", 10 ft.	HA27		Non-Buffered Non-Brushed	23.43	22.49	22.02	21.56	20.62
				Buffered or Brushed	35.37	33.96	33.25	32.54	31.13
110737	"L", 1" x 1/4", 10 ft.	HA3		Non-Buffered Non-Brushed	13.31	12.78	12.51	12.25	11.71
				Buffered or Brushed	23.77	22.82	22.34	21.87	20.92
110738	H-Channel, 7/16" x 1-3/4", 12 ft.			Non-Buffered Non-Brushed	78.82	75.67	74.09	72.51	69.39
110739	Trim, 1" x 1", 12 ft., (Works with base 412007)			Non-Buffered Non-Brushed	30.24	29.03	28.43	27.82	26.61
				Buffered or Brushed	34.37	33.00	32.31	31.62	30.25

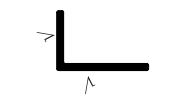
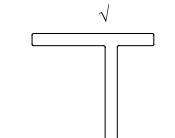
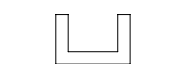
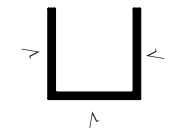
Part Number	Description	Cat. Page Ref.	View	Finish	Discount Quantity Pricing				
					1-5	6-10	11-24	25-99	100+
110741	Trim, 2" Bullnose, 12 ft.	AT15		Non-Buffered Non-Brushed	89.50	85.92	84.13	82.34	78.76
				Buffered or Brushed	95.37	91.56	89.65	87.74	83.93
110747	3" X 3" Square Tube, 1/8" Thick, 12 ft.	HA30		Non-Buffered Non-Brushed	203.69	195.54	191.47	187.39	179.25
				Buffered or Brushed	225.35	216.34	211.83	207.32	198.31
110750	U Channel, 7/8" x 1-1/2", 12 ft.	HA11		Non-Buffered Non-Brushed	36.56	35.10	34.37	33.64	32.17
				Buffered or Brushed	41.65	39.98	39.15	38.32	36.65
110757	U Channel, 3/4" x 3/4", 12 ft.	HA10		Non-Buffered Non-Brushed	35.89	34.45	33.74	33.02	31.58
				Buffered or Brushed	44.82	43.03	42.13	41.23	39.44
110760	U Channel, .938" x .313", 12 ft.	HA11		Non-Buffered Non-Brushed	14.68	14.09	13.80	13.51	12.92
				Buffered or Brushed	20.77	19.94	19.52	19.11	18.28
110764	Angle, 7/8" x 3/8" x 1/8", 12 ft.	HA4		Non-Buffered Non-Brushed	22.51	21.61	21.16	20.71	19.81
				Buffered or Brushed	25.47	24.45	23.94	23.43	22.41
110787	Flat Bar, 1-1/2" x 1/8", 12 ft.	HA16		Non-Buffered Non-Brushed	26.64	25.57	25.04	24.51	23.44
				Buffered or Brushed	37.43	35.93	35.18	34.44	32.94
110788	Flat Bar, 3/4" x 1/4", 12 ft.	HA16		Non-Buffered Non-Brushed	30.96	29.72	29.10	28.48	27.24
				Buffered or Brushed	39.70	38.11	37.32	36.52	34.94
110789	Tube, 1" x 1" x 1/8" 12 ft.	HA30		Non-Buffered Non-Brushed	63.35	60.82	59.55	58.28	55.75
				Buffered or Brushed	79.91	76.71	75.12	73.52	70.32
110790	3.5" Bullnose, 12 ft.			Non-Buffered Non-Brushed	132.42	127.12	124.47	121.83	116.53
				Buffered or Brushed	150.56	144.54	141.53	138.52	132.49
110800	Cover T, 1/2" Secure Lip, 12 ft.	SC17		Non-Buffered Non-Brushed	32.31	31.02	30.37	29.73	28.43
				Buffered or Brushed	42.80	41.09	40.23	39.38	37.66

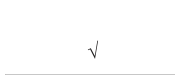

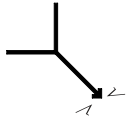

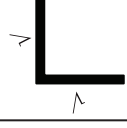

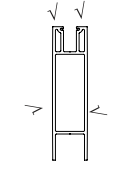
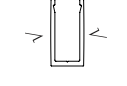
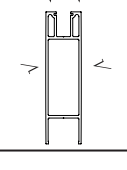
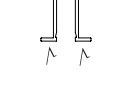
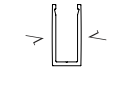
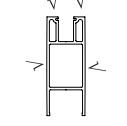

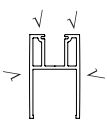
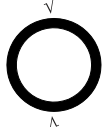
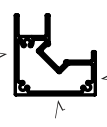
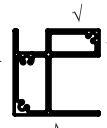
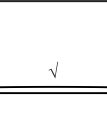
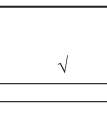
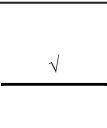
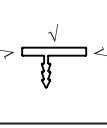
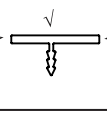
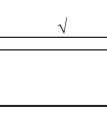
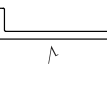

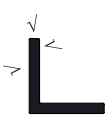
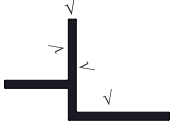
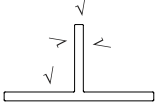
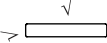

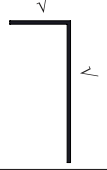
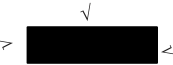
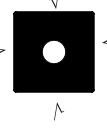
Part Number	Description	Cat. Page Ref.	View	Finish	Discount Quantity Pricing				
					1-5	6-10	11-24	25-99	100+
110810	Bar, 1/4" x 1/4", 12 ft.	HA16		Non-Buffered Non-Brushed	14.06	13.50	13.22	12.94	12.37
				Buffered or Brushed	18.02	17.30	16.94	16.58	15.86
110812	"J" Channel, 1.378" x 2.165", 12 ft.			Non-Buffered Non-Brushed	160.40	153.98	150.78	147.57	141.15
				Buffered or Brushed	187.81	180.30	176.54	172.79	165.27
110813	Door Pull, Extended Grip, 12 ft.			Non-Buffered Non-Brushed	38.54	37.00	36.23	35.46	33.92
				Buffered or Brushed	49.16	47.19	46.21	45.23	43.26
110842	Fluted Trim, 12 ft.			Non-Buffered Non-Brushed	67.83	65.12	63.76	40.24	38.22
				Buffered or Brushed	79.30	76.13	74.54	50.32	47.81
110844	Angle, 4.0" x 1/2" x 1/16", 12 ft.	HA3		Non-Buffered Non-Brushed	54.99	52.79	51.69	50.59	48.39
				Buffered or Brushed	66.01	63.37	62.05	60.73	58.09
110853	Post, Fluted, 12 ft.			Non-Buffered Non-Brushed	60.90	58.46	57.25	56.03	53.59
				Buffered or Brushed	72.93	70.01	68.55	67.10	64.18
110854	Post, Single Groove, 12 ft.			Non-Buffered Non-Brushed	72.41	69.51	68.07	66.62	63.72
				Buffered or Brushed	84.34	80.97	79.28	77.59	74.22
110855	Post, Double Groove, 12 ft.			Non-Buffered Non-Brushed	78.86	75.71	74.13	72.55	69.40
				Buffered or Brushed	90.81	87.18	85.36	83.55	79.91
110863	Tube, Round, 1-1/4" dia x 1/16", 12 ft.	HA29		Non-Buffered Non-Brushed	37.37	35.88	35.13	34.38	32.89
				Buffered or Brushed	44.90	43.10	42.21	41.31	39.51
110866	Angle, 1.380" x 1.00" x .157", 12 ft.	HA4		Non-Buffered Non-Brushed	51.11	49.07	48.04	47.02	44.98
				Buffered or Brushed	61.62	59.16	57.92	56.69	54.23
110926	Bar, Square, 1-1/2", 12 ft.	HA16		Non-Buffered Non-Brushed	342.27	328.58	321.73	314.89	301.20
110950	Tube, Square, 1-1/4" x .09", 12 ft.	HA30		Non-Buffered Non-Brushed	87.24	83.75	82.01	80.26	76.77
				Buffered or Brushed	98.99	95.03	93.05	91.07	87.11

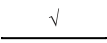
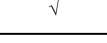
Part Number	Description	Cat. Page Ref.	View	Finish	Discount Quantity Pricing				
					1-5	6-10	11-24	25-99	100+
110951	Door Pull, 1/4" Glass, 12 ft.			Non-Buffered Non-Brushed	40.37	38.76	37.95	37.14	35.53
				Buffered or Brushed	52.23	50.14	49.10	48.05	45.96
110959	3/4" x 3/8" x 1/8" Tee, 12 ft.	HA27		Non-Buffered Non-Brushed	20.03	19.23	18.83	18.43	17.63
				Buffered or Brushed	32.00	30.72	30.08	29.44	28.16
110962	Channel, 5/8" X 1-7/8", 10 ft.	HA11		Non-Buffered Non-Brushed	92.67	88.96	87.11	54.05	51.35
				Buffered or Brushed	103.15	99.02	96.96	63.27	60.11
110963	Angle, 4-1/2" x 2", 12 ft.	HA4		Non-Buffered Non-Brushed	123.53	118.59	116.12	113.65	108.71
				Buffered or Brushed	140.94	135.30	132.48	129.66	124.03
110965	Angle, 1.27" x .512", 12 ft.	HA4		Non-Buffered Non-Brushed	29.27	28.10	27.51	26.93	18.89
				Buffered or Brushed	34.09	32.73	32.04	31.36	23.12
110966	Angle, .787" x .512", 12 ft.	HA3		Non-Buffered Non-Brushed	20.92	20.08	19.66	19.25	13.44
				Buffered or Brushed	24.14	23.17	22.69	22.21	16.28
110975	Tee, 1-1/4" x 1.00" x 1/8", 12 ft.	HA28		Non-Buffered Non-Brushed	43.47	41.73	40.86	39.99	38.25
				Buffered or Brushed	46.15	44.30	43.38	42.46	40.61
110981	Channel, 3/4" x 1/2" x .125", 12 ft.	HA11		Non-Buffered Non-Brushed	27.78	26.67	26.11	25.56	24.45
110984	Channel, 1-1/2" x 1-1/2" x 1/8", 12 ft.	HA11		Non-Buffered Non-Brushed	76.71	73.64	72.11	70.57	67.50
				Buffered or Brushed	79.76	76.57	74.97	73.38	70.19
110986	Angle, 2" x 2-3/4" x 1/8", 12 ft.	HA4		Non-Buffered Non-Brushed	88.49	84.95	83.18	81.41	77.87
				Buffered or Brushed	95.79	91.96	90.04	88.13	84.30
110987	7" x 1/16" Trim Strip, 12 ft.	HA16		Non-Buffered Non-Brushed	74.42	71.44	69.95	68.47	65.49
				Buffered or Brushed	94.21	90.44	88.56	86.67	82.90

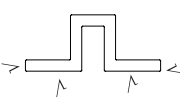
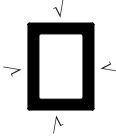

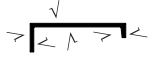
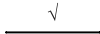
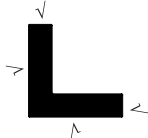
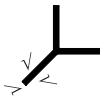

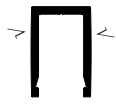

Part Number	Description	Cat. Page Ref.	View	Finish	Discount Quantity Pricing				
					1-5	6-10	11-24	25-99	100+
110993	Trim, Outside Corner, 90°, 12 ft.	HA33		Non-Buffered Non-Brushed	31.23	29.98	29.36	28.73	27.48
				Buffered or Brushed	36.38	34.92	34.20	33.47	32.01
110994	1/2" x 1" x .125" Angle, 12 ft.	HA4		Non-Buffered Non-Brushed	26.00	24.96	24.44	23.92	22.88
				Buffered or Brushed	30.12	28.92	28.31	27.71	26.51
110995	2" x 7/8" Tee, 12 ft.	HA27		Non-Buffered Non-Brushed	51.97	49.89	48.85	47.81	45.73
				Buffered or Brushed	59.54	57.16	55.97	54.78	52.40
110996	1-1/8" x 1-1/8" x 1/8" Angle, 12 ft.	HA3		Non-Buffered Non-Brushed	38.60	37.06	36.28	35.51	33.97
				Buffered or Brushed	43.75	42.00	41.13	40.25	38.50
110997	7/8" x 7/8" x .125" Angle, 12 ft.	HA4		Non-Buffered Non-Brushed	32.37	31.08	30.43	29.78	28.49
				Buffered or Brushed	35.22	33.81	33.11	32.40	30.99
111007	2"x8" WallMaker Sill, 12 ft.	G11		Non-Buffered Non-Brushed	472.41	453.51	444.07	434.62	415.72
				Buffered or Brushed	502.45	482.35	472.30	462.25	442.16
111010	1"x1-3/4" WallMaker Header w/groove, 12 ft.	G7 HA11		Non-Buffered Non-Brushed	60.32	57.91	56.70	55.49	53.08
				Buffered or Brushed	67.94	65.22	63.86	62.50	59.79
111011	2-1/2"x8" WallMaker Sill, 12 ft.	G13		Non-Buffered Non-Brushed	593.12	569.40	557.53	545.67	521.95
				Buffered or Brushed	622.76	597.85	585.39	572.94	548.03
111012	1"x2" WallMaker Flanged Header w/groove, 12 ft.	G8 HA11		Non-Buffered Non-Brushed	90.84	87.21	85.39	83.57	79.94
				Buffered or Brushed	103.47	99.33	97.26	95.19	91.05
111013	1"x2" WallMaker Header w/ groove, 12 ft.	G8 HA11		Non-Buffered Non-Brushed	62.97	60.45	59.19	57.93	55.41
				Buffered or Brushed	83.72	80.37	78.70	77.02	73.67
111014	2-1/2"x6" WallMaker Sill, 12 ft.	G13		Non-Buffered Non-Brushed	441.68	424.01	415.18	406.35	388.68
				Buffered or Brushed	449.90	431.90	422.91	413.91	395.91

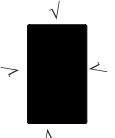
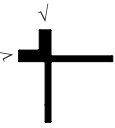
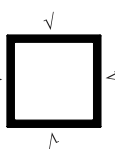
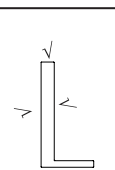
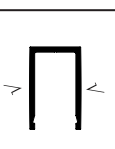
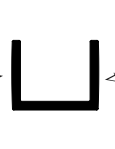
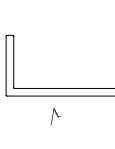
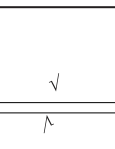
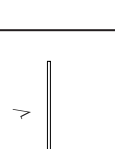
Part Number	Description	Cat. Page Ref.	View	Finish	Discount Quantity Pricing				
					1-5	6-10	11-24	25-99	100+
111015	2-1/2"x4" WallMaker Sill, 12 ft.	G12		Non-Buffered Non-Brushed	291.62	279.96	274.12	268.29	256.63
				Buffered or Brushed	317.99	305.27	298.91	292.55	279.83
111018	5/8" O.D. Tube, .063" thick, 12 ft.	HA29		Non-Buffered Non-Brushed	32.14	30.85	30.21	29.57	20.76
				Buffered or Brushed	37.48	35.98	35.23	34.48	25.45
111022	Post, Open Sell Rear, 12 ft.			Non-Buffered Non-Brushed	95.92	92.08	90.16	88.25	84.41
				Buffered or Brushed	111.78	107.31	105.07	102.84	98.37
111023	Post, Open Sell Front, 12 ft.			Non-Buffered Non-Brushed	99.08	95.12	93.14	91.15	87.19
				Buffered or Brushed	114.10	109.54	107.25	104.97	100.41
111024	3-7/8" x 1/8" " Bar, 12 ft. (.145 crown)	HA16		Non-Buffered Non-Brushed	79.36	76.19	74.60	73.01	69.84
				Buffered or Brushed	85.84	82.41	80.69	78.97	75.54
111025	1-1/4" x 3/16" Flat Bar, 12 ft.	HA16		Non-Buffered Non-Brushed	33.95	32.59	31.91	31.23	29.88
				Buffered or Brushed	38.97	37.41	36.63	35.85	34.29
111026	3-7/8" x 1/8", Rectangle Bar, 12 ft.	HA16		Non-Buffered Non-Brushed	77.97	74.85	73.29	71.73	68.61
				Buffered or Brushed	81.87	78.60	76.96	75.32	72.05
111027	1" x 1/2" x 1/8" T-Shape, 12 ft.	HA28		Non-Buffered Non-Brushed	25.39	24.37	23.87	23.36	22.34
				Buffered or Brushed	30.80	29.57	28.95	28.34	27.10
111028	1-3/8" x 1/2" x 1/8" T-Shape, 12 ft.	HA28		Non-Buffered Non-Brushed	34.29	32.92	32.23	31.55	30.18
				Buffered or Brushed	43.07	41.35	40.49	39.62	37.90
111029	1-1/4" x 1/8" Flat Bar, 12 ft.	HA16		Non-Buffered Non-Brushed	26.27	25.22	24.69	24.17	23.12
				Buffered or Brushed	31.29	30.04	29.41	28.79	27.54
111033	1" x 1/4" U-Channel, 12 ft.	HA10		Non-Buffered Non-Brushed	16.03	15.39	15.07	14.75	14.11
				Buffered or Brushed	22.28	21.39	20.94	20.50	19.61

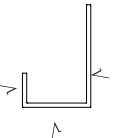



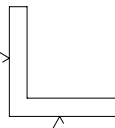
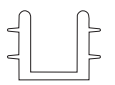
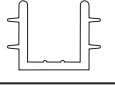
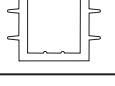
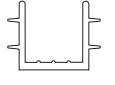

Part Number	Description	Cat. Page Ref.	View	Finish	Discount Quantity Pricing				
					1-5	6-10	11-24	25-99	100+
111034	11/16" x 11/16" x 3/32" Angle, 12 ft.	HA4		Non-Buffered Non-Brushed	19.79	19.00	18.60	18.21	17.42
				Buffered or Brushed	29.27	28.10	27.51	26.93	25.76
111035	1-3/16" x 1-3/16" x 3/32" Angle with 3/4" Return, 12 ft.	HA4		Non-Buffered Non-Brushed	40.14	38.53	37.73	36.93	35.32
				Buffered or Brushed	54.03	51.87	50.79	49.71	47.55
111036	1.594" x 0.719" x 3/32" Tee, 12 ft.	HA28		Non-Buffered Non-Brushed	37.21	35.72	34.98	34.23	32.74
				Buffered or Brushed	44.72	42.93	42.04	41.14	39.35
111037	3/32" x 0.594" Bar, 12 ft.	HA16		Non-Buffered Non-Brushed	14.71	14.12	13.83	13.53	12.94
				Buffered or Brushed	24.20	23.23	22.75	22.26	21.30
111038	6.45" x 1/2" Bar, 12 ft.	HA16		Non-Buffered Non-Brushed	452.18	434.09	425.05	416.01	397.92
				Buffered or Brushed	469.76	450.97	441.57	432.18	413.39
111039	5-1/4" x 2-1/4" x 1/8" Angle, 12 ft.	HA4		Non-Buffered Non-Brushed	118.24	113.51	111.15	108.78	104.05
				Buffered or Brushed	137.41	131.91	129.17	126.42	120.92
111040	1-3/4" x 1/2" Bar, 12 ft.	HA16		Non-Buffered Non-Brushed	135.27	129.86	127.15	124.45	119.04
				Buffered or Brushed	150.29	144.28	141.27	138.27	132.26
111046	3/8" x 3/8" Square Bar with 0.110" dia hole, 12 ft.	HA30		Non-Buffered Non-Brushed	23.57	22.63	22.16	21.68	20.74
				Buffered or Brushed	31.01	29.77	29.15	28.53	27.29
111048	Door Pull, 1-1/2" x 3/4", 12 ft.			Non-Buffered Non-Brushed	57.36	55.07	53.92	52.77	34.91
				Buffered or Brushed	66.33	63.68	62.35	61.02	42.80
111050	5" x 1/8", Rectangle Bar, 12 ft.	HA16		Non-Buffered Non-Brushed	99.63	95.64	93.65	91.66	87.67
				Buffered or Brushed	103.52	99.38	97.31	95.24	91.10
111051	5-3/4" x 1/8" Rectangle Bar, 12 ft.	HA16		Non-Buffered Non-Brushed	112.80	108.29	106.03	103.78	99.26
				Buffered or Brushed	116.71	112.04	109.71	107.37	102.70



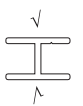
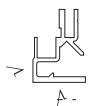
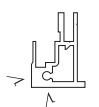

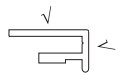
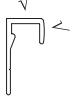
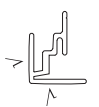

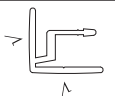
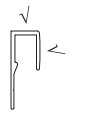
Part Number	Description	Cat. Page Ref.	View	Finish	Discount Quantity Pricing				
					1-5	6-10	11-24	25-99	100+
111053	Channel, Hat Header, 1-1/2" x 5/8", 12 ft.	HA10		Non-Buffered Non-Brushed	48.93	46.97	45.99	45.02	43.06
				Buffered or Brushed	58.64	56.29	55.12	53.95	51.60
111058	Tube, Rect. 1" x 3/4" x 1/8", 12 ft.	HA30		Non-Buffered Non-Brushed	65.33	62.72	61.41	60.10	57.49
				Buffered or Brushed	72.73	69.82	68.37	66.91	64.00
111059	Rod, .312 Dia., 12 ft.	HA29		Non-Buffered Non-Brushed	15.24	14.63	14.33	14.02	13.41
				Buffered or Brushed	22.54	21.64	21.19	20.74	19.84
111060	Door Pull, 2-1/2" x 3/4", 12 ft.			Non-Buffered Non-Brushed	54.32	52.15	51.06	49.97	47.80
				Buffered or Brushed	68.39	65.65	64.29	62.92	60.18
111061	Bar, 2-1/2" x .070", 12 ft.	HA16		Non-Buffered Non-Brushed	32.74	31.43	30.78	30.12	28.81
				Buffered or Brushed	36.67	35.20	34.47	33.74	32.27
111062	Angle, 1" x 1" x 1/4", 12 ft.	HA3		Non-Buffered Non-Brushed	46.47	44.61	43.68	42.75	40.89
				Buffered or Brushed	53.79	51.64	50.56	49.49	47.34
111068	Molding Y, 1" x 1" x 1", 12 ft.	F14		Non-Buffered Non-Brushed	57.68	55.37	54.22	53.07	50.76
				Buffered or Brushed	64.92	62.32	61.02	59.73	57.13
111071	Angle, 1-1/4" x 1-1/4" x 1/8", 12 ft.	HA3		Non-Buffered Non-Brushed	40.49	38.87	38.06	37.25	35.63
				Buffered or Brushed	50.94	48.90	47.88	46.86	44.83
111072	Channel, 1" X 1-1/2" with Groove, 12 ft.	HA10		Non-Buffered Non-Brushed	68.73	65.98	64.61	63.23	60.48
				Buffered or Brushed	76.01	72.97	71.45	69.93	66.89
111073	Bar, 2-1/2" x 1/2", 12 ft.	HA16		Non-Buffered Non-Brushed	167.55	160.85	157.50	154.15	147.44
				Buffered or Brushed	181.60	174.34	170.70	167.07	159.81
111077	Angle, 1-1/2" x 1/2" x 1/8", 12 ft.			Non-Buffered Non-Brushed	38.15	36.62	35.86	35.10	33.57
				Buffered or Brushed	45.46	43.64	42.73	41.82	40.00

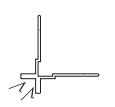

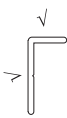
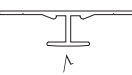
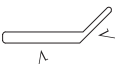

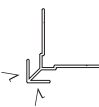
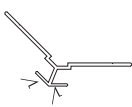

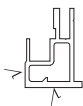
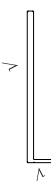

Part Number	Description	Cat. Page Ref.	View	Finish	Discount Quantity Pricing				
					1-5	6-10	11-24	25-99	100+
111078	Bar, Rectangle 1-1/4" x 3/4", 12 ft.	HA16		Non-Buffered Non-Brushed	128.80	123.65	121.07	118.50	113.34
				Buffered or Brushed	142.85	137.14	134.28	131.42	125.71
111082	Edge Moulding, .563 Column, 12 ft.			Non-Buffered Non-Brushed	102.54	98.44	96.39	94.34	90.24
				Buffered or Brushed	109.77	105.38	103.18	100.99	96.60
111083	Tube, Square 1-1/2" x 1-1/2" x .120, 12 ft.	HA30		Non-Buffered Non-Brushed	101.55	97.49	95.46	93.43	89.36
				Buffered or Brushed	115.58	110.96	108.65	106.33	101.71
111085	Angle, 2" x 1", Unequal Walls, 12 ft.	HA		Non-Buffered Non-Brushed	79.86	76.67	75.07	73.47	70.28
				Buffered or Brushed	87.89	84.37	82.62	80.86	77.34
111089	Channel, 1-1/4" x 2", with Groove, 12 ft. (End cap Part number 412456)	G7 HA10		Non-Buffered Non-Brushed	67.56	64.86	63.51	62.16	59.45
				Buffered or Brushed	90.08	86.48	84.68	82.87	79.27
111091	Channel, 1-1/4" x 1", 12 ft. (End cap Part number 412457)	G8 HA10		Non-Buffered Non-Brushed	42.91	41.19	40.34	39.48	37.76
				Buffered or Brushed	55.66	53.43	52.32	51.21	48.98
111094	Angle, 2" x 1" x 1/8", 12 ft.	HA4		Non-Buffered Non-Brushed	54.20	52.03	50.95	49.86	47.70
				Buffered or Brushed	60.67	58.24	57.03	55.82	53.39
111095	Flat Bar, 2" x 1/8", 12 ft.	HA16		Non-Buffered Non-Brushed	37.03	35.55	34.81	34.07	32.59
				Buffered or Brushed	43.12	41.40	40.53	39.67	37.95
111097	Angle, 2" x 4" x 1/8", 12 ft.	HA4		Non-Buffered Non-Brushed	107.14	102.85	100.71	98.57	94.28
				Buffered or Brushed	119.23	114.46	112.08	109.69	104.92

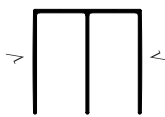

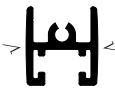
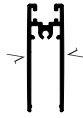
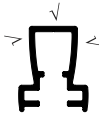
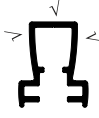
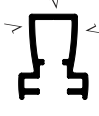

Part Number	Description	Cat. Page Ref.	View	Finish	Discount Quantity Pricing				
					1-5	6-10	11-24	25-99	100+
111098	J-Channel, 2" x 1" x 3", 12 ft.			Non-Buffered Non-Brushed	105.61	101.39	99.27	97.16	92.94
				Buffered or Brushed	118.68	113.93	111.56	109.19	104.44
111103	Samsara, 3.99" x .722", 12 ft.	AT19		Non-Buffered Non-Brushed	57.42	55.12	53.97	52.83	50.53
				Buffered or Brushed	65.70	63.07	61.76	60.44	57.82
111104	Equalizer, 3.99" x .723", 12 ft.	AT19		Non-Buffered Non-Brushed	66.97	64.29	62.95	61.61	58.93
				Buffered or Brushed	75.27	72.26	70.75	69.25	66.24
111107	Gamma, 3.99" x .972", 12 ft.	AT20		Non-Buffered Non-Brushed	89.08	85.52	83.74	81.95	78.39
				Buffered or Brushed	97.38	93.48	91.54	89.59	85.69
111108	Angle, 3/4" x 3/4" x 1/8", 12 ft.			Non-Buffered Non-Brushed	26.40	25.34	24.82	24.29	23.23
				Buffered or Brushed	30.72	29.49	28.88	28.26	27.03
119001	3/16" Black Vinyl Glazing Tape, (comes in 250 ft. coil)	HA36		Black Vinyl	.29/ft.	.28/ft.	.27/ft.	.27/ft.	.26/ft.
119003-01	7/32" Black Vinyl Glazing Tape (comes in 250 ft. coil)	HA36		Black Vinyl	.17/ft.	.16/ft.	.16/ft.	.16/ft.	.15/ft.
119003-02	7/32" Grey Vinyl Glazing Tape (comes in 250 ft. coil)	HA36		Grey Vinyl	.18/ft.	.17/ft.	.17/ft.	.17/ft.	.16/ft.
119004	1/4" Black Vinyl Glazing Tape (comes in 250 ft. coil)	HA36 RD15 FM15		Black Vinyl	.26/ft.	.25/ft.	.24/ft.	.24/ft.	.23/ft.
119006	Black Vinyl Track Slide Insert, 12 ft. (used with 110035)	FM15		Black Vinyl	13.09	13.34	13.07	12.79	12.23
119045-01	Glazing, 196.85 inches (5m)				78.00	74.88	73.32	71.76	68.64
119029	Vinyl Bumper - Natural Color 6 ft.	SC15		Natural Color	12.48	11.98	11.73	11.48	10.98



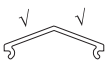
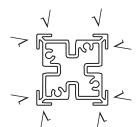
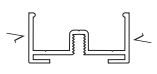
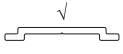
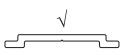
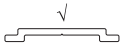
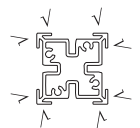
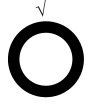

Part Number	Description	Cat. Page Ref.	View	Finish	Discount Quantity Pricing				
					1-5	6-10	11-24	25-99	100+
120016	Division Bar, 12 ft.			Non-Buffered Non-Brushed	10.84	10.41	10.19	9.97	9.54
				Buffered or Brushed	13.35	12.82	12.55	12.28	11.75
120029	Fixed Mirror Frame, 12 ft.	FM11		Non-Buffered Non-Brushed	41.38	39.72	38.90	38.07	36.41
				Buffered or Brushed	52.59	50.49	49.43	48.38	46.28
120030	Tri-View Frame, 137"	FM11		Non-Buffered Non-Brushed	49.22	47.25	46.27	45.28	43.31
				Buffered or Brushed	60.43	58.01	56.80	55.60	53.18
120031	Top Hanger, 124"	FM11		Non-Buffered Non-Brushed	22.08	21.20	20.76	20.31	19.43
120032	Lower Hanger, 124"	FM11		Non-Buffered Non-Brushed	18.74	17.99	17.62	17.24	16.49
120034	Panel Trim, 132"	FM11		Non-Buffered Non-Brushed	17.36	16.67	16.32	15.97	15.28
				Buffered or Brushed	24.11	23.15	22.66	22.18	21.22
120041	5/16" J Molding Without Holes, 12 ft. (see 420068 - with holes)	FM15		Non-Buffered Non-Brushed	12.88	12.36	12.11	11.85	11.33
				Buffered or Brushed	18.12	17.40	17.03	16.67	15.95
120050	Mirror Frame, 12 ft.	FM14		Buffered or Brushed	40.17	38.56	37.76	36.96	35.35
120052	Mount Bracket, 12 ft.	FM14		Non-Buffered Non-Brushed	12.42	11.92	11.67	11.43	10.93
120054	Mirror Frame, 12 ft.	FM14		Buffered or Brushed	29.57	28.39	27.80	27.20	26.02
120055	5/8" J Molding Without Holes, 12 ft. (420107 with holes)	FM15		Non-Buffered Non-Brushed	17.28	16.59	16.24	15.90	15.21
				Buffered or Brushed	21.62	20.76	20.32	19.89	19.03
120057	Mirror Molding, 12 ft. (420108 with holes)	FM15		Non-Buffered Non-Brushed	13.97	13.41	13.13	12.85	12.29
				Buffered or Brushed	18.00	17.28	16.92	16.56	15.84
120058	Column Edge Molding, 12 ft.	FM15		Non-Buffered Non-Brushed	39.55	37.97	37.18	36.39	34.80
				Buffered or Brushed	57.47	55.17	54.02	52.87	50.57

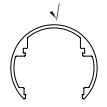



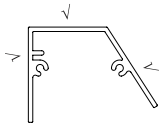
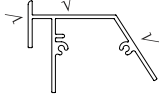
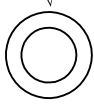
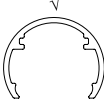
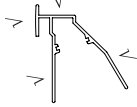

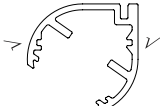
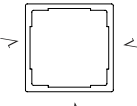
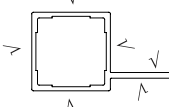
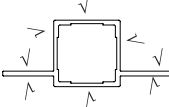

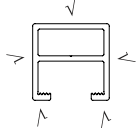
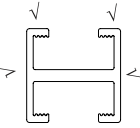
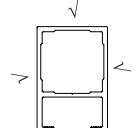
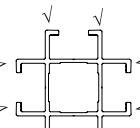
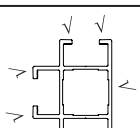
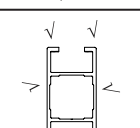
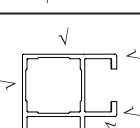
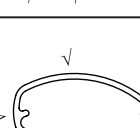
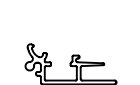
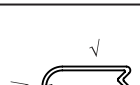
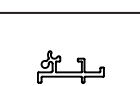

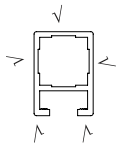
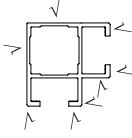

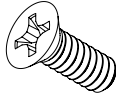
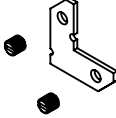
Part Number	Description	Cat. Page Ref.	View	Finish	Discount Quantity Pricing				
					1-5	6-10	11-24	25-99	100+
120059	5/16" x 5/8" Mirror Trim Angle, 12 ft.	FM14 HA3		Non-Buffered Non-Brushed	10.11	9.71	9.50	9.30	8.90
				Buffered or Brushed	15.88	15.24	14.93	14.61	13.97
120061	Mirror Divider Trim without holes, 12 ft. (420109 with holes)	FM15		Non-Buffered Non-Brushed	21.20	20.35	19.93	19.50	18.66
				Buffered or Brushed	25.45	24.43	23.92	23.41	22.40
120062	45° Trim Mirror, 12 ft.	FM17		Non-Buffered Non-Brushed	22.40	21.50	21.06	20.61	19.71
				Buffered or Brushed	27.32	26.23	25.68	25.13	24.04
120063	Column Corner without Slots, 150" (420110 with slots)	FM16		Non-Buffered Non-Brushed	54.53	52.35	51.26	50.17	47.99
				Buffered or Brushed	61.86	59.39	58.15	56.91	54.44
120064	1-1/2" Radius Column Corner, 12 ft.	FM16		Non-Buffered Non-Brushed	66.75	64.08	62.75	61.41	58.74
				Buffered or Brushed	68.27	65.54	64.17	62.81	60.08
120065	90° Column Mirror Trim, 12 ft.	FM17		Non-Buffered Non-Brushed	46.03	44.19	43.27	42.35	40.51
				Buffered or Brushed	54.97	52.77	51.67	50.57	48.37
120066	135° Column Trim, 12 ft.	FM17		Non-Buffered Non-Brushed	40.02	38.42	37.62	36.82	35.22
				Buffered or Brushed	57.26	54.97	53.82	52.68	50.39
120067	Outside Corner Molding, 12 ft.	FM17		Non-Buffered Non-Brushed	38.97	37.41	36.63	35.85	34.29
120070	Tri-View Wing Horizontal, 137"	FM11		Non-Buffered Non-Brushed	42.58	40.88	40.03	39.17	37.47
				Buffered or Brushed	52.18	50.09	49.05	48.01	45.92
120086	Angle, 3" x 1/2", 12 ft.	HA4		Non-Buffered Non-Brushed	66.76	64.09	62.75	61.42	58.75
				Buffered or Brushed	77.52	74.42	72.87	71.32	68.22
129006	Gray Plastic Glazing Clip, 12 ft.	FM16		Non-Buffered Non-Brushed	13.73	13.18	12.91	12.63	12.08

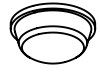





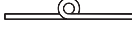

Part Number	Description	Cat. Page Ref.	View	Finish	Discount Quantity Pricing				
					1-5	6-10	11-24	25-99	100+
130022	Header, Door Wardrobe, 12 ft.	RD17		Non-Buffered Non-Brushed	87.63	84.12	82.37	80.62	77.11
				Buffered or Brushed	101.73	97.66	95.63	93.59	89.52
130023	Threshold, Wardrobe Door, 12 ft.	RD17		Non-Buffered Non-Brushed	48.33	46.40	45.43	44.46	42.53
130024	Top Rail, Wardrobe Door, 12 ft.			Non-Buffered Non-Brushed	29.04	27.88	27.30	26.72	25.56
				Buffered or Brushed	36.34	34.89	34.16	33.43	31.98
130025	Bottom Rail, Wardrobe Door, 12 ft.			Non-Buffered Non-Brushed	54.75	52.56	51.47	50.37	48.18
				Buffered or Brushed	62.08	59.60	58.36	57.11	54.63
130026	Stile, Wardrobe Door, 79"	RD17		Non-Buffered Non-Brushed	22.49	21.59	21.14	20.69	19.79
				Buffered or Brushed	33.26	31.93	31.26	30.60	29.27
130027	Stile, Wardrobe Door, 106"	RD17		Non-Buffered Non-Brushed	52.33	50.24	49.19	48.14	46.05
				Buffered or Brushed	73.82	70.87	69.39	67.91	64.96
130028	Stile, Wardrobe Door, 95"	RD17		Non-Buffered Non-Brushed	24.48	23.50	23.01	22.52	21.54
				Buffered or Brushed	34.67	33.28	32.59	31.90	30.51
139007	1/4" Black Vinyl Glazing, (comes in 500/ft. roll)	RD17		Black Vinyl	.21/ft.	.21/ft.	.21/ft.	.21/ft.	.21/ft.
150012	3-1/8" x 5/64" Strip, 8 ft.	HA16		Non-Buffered Non-Brushed	38.39	36.85	36.09	35.32	33.78
				Buffered or Brushed	53.64	51.49	50.42	49.35	47.20
150014	1-1/2" x 3/4" Tubular Bracket Endcap, 12 ft.	HA27		Non-Buffered Non-Brushed	26.48	25.42	24.89	24.36	23.30
				Buffered or Brushed	32.78	31.47	30.81	30.16	28.85
150015	1" x 1/2" Tubular Bracket Hanger, 8 ft.			Non-Buffered Non-Brushed	51.04	49.00	47.98	46.96	44.92
				Buffered or Brushed	70.18	67.37	65.97	64.57	61.76
170008	Wall Jamb Without Holes, 12 ft. (see 470012 for Wall Jamb with holes)	HA10		Non-Buffered Non-Brushed	28.81	27.66	27.08	26.51	25.35
				Buffered or Brushed	36.95	35.47	34.73	33.99	32.52

Part Number	Description	Cat. Page Ref.	View	Finish	Discount Quantity Pricing				
					1-5	6-10	11-24	25-99	100+
170009	Header Cap, 12 ft.	FM3		Non-Buffered Non-Brushed	21.24	20.39	19.97	19.54	18.69
				Buffered or Brushed	28.82	27.67	27.09	26.51	25.36
170011	Corner Post, 7 ft.	FM3		Non-Buffered Non-Brushed	52.82	50.71	49.65	48.59	46.48
				Buffered or Brushed	62.07	59.59	58.35	57.10	54.62
170012	Jamb Header, 12 ft.	FM3		Non-Buffered Non-Brushed	35.98	34.54	33.82	33.10	31.66
				Buffered or Brushed	42.09	40.41	39.59	38.72	37.04
170013	Filler Strip for 170011, 7 ft.	FM3		Non-Buffered Non-Brushed	10.35	9.94	9.73	9.52	9.11
				Buffered or Brushed	13.13	12.60	12.34	12.08	11.55
170013-01	Filler Strip for 170011, 8 ft.	FM3		Non-Buffered Non-Brushed	11.00	10.56	10.34	10.12	9.68
				Buffered or Brushed	13.76	13.21	12.93	12.66	12.11
170013-02	Filler Strip for 170014, 12 ft.	FM3		Non-Buffered Non-Brushed	13.86	13.31	13.03	12.75	12.20
				Buffered or Brushed	16.30	15.65	15.32	15.00	14.34
170014	Corner Post, 12 ft.	FM3		Non-Buffered Non-Brushed	107.30	103.01	100.86	98.72	94.42
				Buffered or Brushed	117.75	113.04	110.69	108.33	103.62
180055	3/8" O.D. Tube, 0.100" Thick, 12 ft.	HA29		Non-Buffered Non-Brushed	18.06	17.34	16.98	16.62	15.89
				Buffered or Brushed	23.22	22.29	21.83	21.36	20.43
180063	1-1/4" Tee, 12 ft.	HA28		Non-Buffered Non-Brushed	46.22	44.37	43.45	42.52	40.67
				Buffered or Brushed	59.37	57.00	55.81	54.62	52.25
180077	1-1/4" Elongated Reflector, 12 ft.	SC18		Non-Buffered Non-Brushed	43.74	41.99	41.12	40.24	38.49
				Buffered or Brushed	52.63	50.52	49.47	48.42	46.31
180079	Shell Reflector, 1-1/2" Dia., 12 ft.	SC18		Non-Buffered Non-Brushed	45.23	43.42	42.52	41.61	39.80
				Buffered or Brushed	50.94	48.90	47.88	46.86	44.83
180107	Shell Reflector, 1" Dia., 12 ft.	SC17		Non-Buffered Non-Brushed	24.96	23.96	23.46	22.96	21.96
				Buffered or Brushed	33.82	32.47	31.79	31.11	29.76

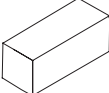
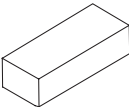









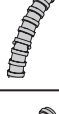

Part Number	Description	Cat. Page Ref.	View	Finish	Discount Quantity Pricing				
					1-5	6-10	11-24	25-99	100+
180117	Shell Reflector, Small, 12 ft.	SC18		Non-Buffered Non-Brushed	33.04	31.72	31.06	30.40	29.08
				Buffered or Brushed	37.42	35.92	35.17	34.43	32.93
180118	Shell Reflector Small with Integrated Tee, 12 ft.	SC18		Non-Buffered Non-Brushed	43.37	41.64	40.77	39.90	38.17
				Buffered or Brushed	56.72	54.45	53.32	52.18	49.91
180127	0.448" O.D. Tube, 0.162" thick, 12 ft.	HA29		Non-Buffered Non-Brushed	16.13	15.48	15.16	14.84	14.19
				Buffered or Brushed	18.97	18.21	17.83	17.45	16.69
180133	Shell Reflector 1" Dia. 12 ft.	SC18		Non-Buffered Non-Brushed	23.48	22.54	22.07	21.60	20.66
				Buffered or Brushed	30.39	29.17	28.57	27.96	26.74
180139	Shell Reflector, Top Front Frame, 12 ft.	SC18		Non-Buffered Non-Brushed	57.60	55.30	54.14	52.99	50.69
				Buffered or Brushed	64.71	62.12	60.83	59.53	56.94
180144	Shell Reflector, 1.3" Dia. 12 ft.	SC18		Non-Buffered Non-Brushed	38.70	37.15	36.38	35.60	34.06
				Buffered or Brushed	47.60	45.70	44.74	43.79	41.89
180147	Shell Reflector Teardrop, 1.5" Dia., 12 ft.	SC18		Non-Buffered Non-Brushed	58.87	56.52	55.34	54.16	51.81
				Buffered or Brushed	63.23	60.70	59.44	58.17	55.64
180150	Shell Reflector Teardrop, 1.5" Dia., 12 ft.	SC18		Non-Buffered Non-Brushed	60.80	58.37	57.15	55.94	53.50
				Buffered or Brushed	67.99	65.27	63.91	62.55	59.83
190001	Tube, 1" x 1", 12 ft.	G23		Non-Buffered Non-Brushed	38.21	36.68	35.92	35.15	33.62
				Buffered or Brushed	42.41	40.71	39.87	39.02	37.32
190003	Sq. Tube, 1" X 1" with Flange, 12 ft.	G23		Non-Buffered Non-Brushed	59.09	56.73	55.54	54.36	52.00
				Buffered or Brushed	69.18	66.41	65.03	63.65	60.88
190007	Sq. Tube, 1" x 1" with 2 Flanges at 180°, 12 ft.	G23		Non-Buffered Non-Brushed	59.07	56.71	55.53	54.34	51.98
				Buffered or Brushed	79.51	76.33	74.74	73.15	69.97







Part Number	Description	Cat. Page Ref.	View	Finish	Discount Quantity Pricing				
					1-5	6-10	11-24	25-99	100+
190014	Square 1" with Channel, 12 ft. (works with end cap 241014)	G23		Non-Buffered Non-Brushed	47.71	45.80	44.85	43.89	41.98
				Buffered or Brushed	54.53	52.35	51.26	50.17	47.99
190015	Double Square 1" with Channel, 12 ft. (works with end cap 241015)	G23		Non-Buffered Non-Brushed	46.51	44.65	43.72	42.79	40.93
				Buffered or Brushed	52.55	50.45	49.40	48.35	46.24
190019	Channel, Single, 1" x 1-1/2", 12 ft. (Works with endcap 390031)	G23		Non-Buffered Non-Brushed	54.10	51.94	50.85	49.77	47.61
				Buffered or Brushed	67.54	64.84	63.49	62.14	59.44
190022	Channel, 4-Way, 2" x 2", 12 ft. (Works with endcap 241038)	G24		Non-Buffered Non-Brushed	105.28	101.07	98.96	96.86	92.65
				Buffered or Brushed	111.94	107.46	105.22	102.98	98.51
190023	Channel, 3-Way, 1-1/2" x 2", 12 ft. (Works with endcap 241001)	G24		Non-Buffered Non-Brushed	86.97	83.49	81.75	80.01	76.53
				Buffered or Brushed	102.66	98.55	96.50	94.45	90.34
190026	Channel, Double, 1" x 2", 12 ft. (Works with endcap 241004)	G24		Non-Buffered Non-Brushed	68.75	66.00	64.63	63.25	60.50
				Buffered or Brushed	79.92	76.72	75.12	73.53	70.33
190042	Channel, Double, 1-1/2" x 1-1/2", 12 ft. (Works with endcap 241003)			Non-Buffered Non-Brushed	71.15	68.30	66.88	65.46	62.61
				Buffered or Brushed	88.07	84.55	82.79	81.02	77.50
190054	Frame, .080" x 1", 8.5 ft.			Non-Buffered Non-Brushed	14.10	13.54	13.25	12.97	12.41
				Buffered or Brushed	17.76	17.05	16.69	16.34	15.63
190056	Back Frame, 1" Print Frame, 8.5 ft.			Non-Buffered Non-Brushed	11.73	11.26	11.03	10.79	10.32
190061	Snap Frame, 1-3/8", 8.5 ft.			Non-Buffered Non-Brushed	20.07	19.27	18.87	18.46	17.66
				Buffered or Brushed	25.19	24.18	23.68	23.17	22.17
190093	Back Frame, 1-3/8" PrintFrame, 102"			Non-Buffered Non-Brushed	29.31	28.14	27.55	26.97	25.79

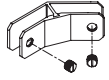
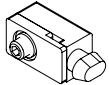
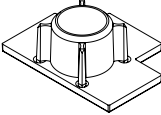

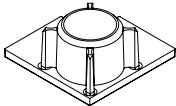
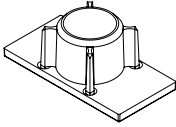
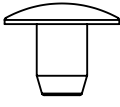
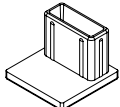
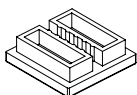
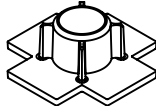

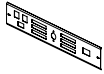
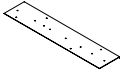
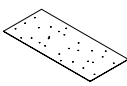







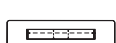
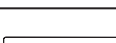

Part Number	Description	Cat. Page Ref.	View	Finish	Discount Quantity Pricing				
					1-5	6-10	11-24	25-99	100+
190128	Channel, .750" x 1.063", 12 ft.			Non-Buffered Non-Brushed	39.08	37.52	36.74	35.95	34.39
				Buffered or Brushed	54.55	52.37	51.28	50.19	48.00
190129	Double Channel, .750" x 1.378", 12 ft.			Non-Buffered Non-Brushed	50.74	48.71	47.70	46.68	44.65
				Buffered or Brushed	68.28	65.55	64.18	62.82	60.09
190172	Angle, 1" x 1" x .125, 12 ft.	HA3		Non-Buffered Non-Brushed	31.58	30.32	29.69	29.05	27.79
				Buffered or Brushed	45.81	43.98	43.06	42.15	40.31
211042	Flat Head Machine Screw #6-32 x 3/8" Phil	S15		Zinc Plated Steel	0.05	0.05	0.05	0.05	0.05
217008	Corner Bracket Plate with Screws			Zinc	0.30	0.30	0.30	0.30	0.30
218035	Fender Washer 1-1/2" O.D.	SC29			0.10	0.10	0.10	0.10	0.10
221014	Gray Bumper	FM11 RD15		Gray Rubber	0.30	0.30	0.30	0.30	0.30
221015	Clear Bumper	RD15		Clear Rubber	0.30	0.30	0.30	0.30	0.30
222012	1/8" x 3/16" Rivet			Steel Zinc	0.30	0.30	0.30	0.30	0.30
222023	Cartridge Rivet, 1821-0412			Steel	0.15	0.15	0.15	0.15	0.15
222025	Rivet, 1/8 x 0.085-0.135 Stl Zinc			Steel	0.10	0.10	0.10	0.10	0.10
224007	1" Piano Hinge without Holes, 8 ft. (see 419020 with holes)	HA34		Non-Buffered Non-Brushed	15.17	14.56	14.26	13.96	13.35
224008	1-1/2" Piano Hinge with Holes, 8 ft.	HA34 S15		Non-Buffered Non-Brushed	21.14	20.29	19.87	19.45	18.60
224009	1-1/2" Piano Hinge without Holes, 8 ft.	HA34 S15		Non-Buffered Non-Brushed	18.60	17.86	17.48	17.11	16.37







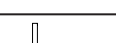
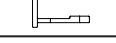



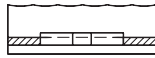





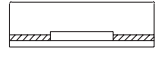

Part Number	Description	Cat. Page Ref.	View	Finish	Discount Quantity Pricing				
					1-5	6-10	11-24	25-99	100+
224022	3-1/2" Brushed Nickel Butt Hinge	FM4		Brushed Nickel	15.17	15.17	15.17	15.17	15.17
226010	Felt Tape: 3/4" x 1/16" x 132"	HA36	Felt Tape Available in -01 Grey, -02 Brown and -03 Beige	Felt Tape	5.79	5.79	5.79	5.79	5.10
226011	Felt Tape: 1-3/4" x 1/16" x 84"	HA36	Felt Tape Available in -01 Grey and -03 Beige	Felt Tape	9.39	9.39	9.39	9.39	8.26
226012	Felt Tape: 1-3/16" x 1/16" x 84"	HA36	Felt Tape Available in -01 Grey, 02 Brown and -03 Beige	Felt Tape	7.70	7.70	7.70	7.70	6.78
226013	WallMaker Glazing Vinyl, 1/2" (comes in 125ft. per roll)	G4		Black Rubber	.50/ft.	.50/ft.	.50/ft.	.50/ft.	.50/ft.
226014	Setting Block, 1/2" x 5/8" x 4"	G5		Black Rubber	0.90	0.90	0.90	0.90	0.90
226015	Setting Block, 1/4" x 5/8" x 4"	G5		Black Rubber	0.55	0.55	0.55	0.55	0.55
226016	WallMaker Glazing Vinyl, 1/4" (comes in 125 ft. roll)	G4		Black Rubber	.56/ft.	.56/ft.	.56/ft.	.56/ft.	.56/ft.
226019	Tape, Foam 1/4" x 5/16" x 14 ft.			Grey	1.44/roll	1.44/roll	1.44/roll	1.44/roll	1.44/roll
226021	3/8" Glazing Strip	G4		Black Rubber	.36/ft.	.36/ft.	.36/ft.	.36/ft.	.36/ft.
226022	3/8" Glazing Strip with Hook	G4		Black Rubber	.36/ft.	.36/ft.	.36/ft.	.36/ft.	.36/ft.
226023	Glass Setting Tape, 100 ft. Roll			Black	.43/ft.	.43/ft.	.43/ft.	.43/ft.	.43/ft.
226024	Outside Rubber Glazing, 1/2" Glass	G4		Black Rubber	.31/ft.	.31/ft.	.31/ft.	.31/ft.	.31/ft.
226025	Inside Rubber Glazing, 1/2" Glass	G4		Black Rubber	.31/ft.	.31/ft.	.31/ft.	.31/ft.	.31/ft.
226027-01	9/16" x 1/16" Grey Felt, 8 ft.	G8		Grey Felt	8.33	8.33	8.33	8.33	7.33
227025	Suction Cup, 4-1/2" Dia, 80lbs Capacity				8.00	8.00	8.00	8.00	8.00
230028	Receptacle, Grounded	SC32			2.49	2.49	2.49	2.49	2.49













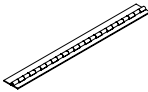

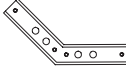
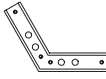

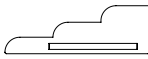

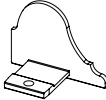

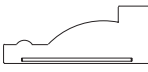
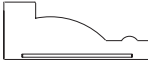

Part Number	Description	Cat. Page Ref.	View	Finish	Discount Quantity Pricing				
					1-5	6-10	11-24	25-99	100+
230056	Super Flex Conduit (3/8" I.D.), 250ft roll (No UL Listing / Recognition on conduit) Per Roll	SC31		Galvanized Steel	188.13	180.60	176.84	173.08	165.55
230056-01	Super Flex Conduit (3/8" I.D.), (No UL Listing / Recognition on conduit) 7 ft.	SC31		Galvanized Steel	5.46	5.24	5.13	5.02	4.80
230056-02	Super Flex Conduit (3/8" I.D.), (No UL Listing / Recognition on conduit) 4 ft.	SC31		Galvanized Steel	3.01	2.89	2.83	2.77	2.65
230056-04	Super Flex Conduit (3/8" I.D.), (No UL Listing / Recognition on conduit) Per ft.	SC31		Galvanized Steel	.97/ft.	.93/ft.	.91/ft.	.89/ft.	.85/ft.
230085	Switch, Rocker 20A 125-277 VAC	SC32			8.45	8.45	8.45	8.45	8.45
232006	Steel Bracket, 6" Anochrome	SC15 HA26 SH7		Steel	3.92	3.92	3.92	3.92	3.92
232008	Steel Bracket, 8" Anochrome	SC15 HA26 SH7		Steel	4.14	4.14	4.14	4.14	4.14
232010	Steel Bracket, 10" Anochrome	SC15 HA26 SH7		Steel	4.35	4.35	4.35	4.35	4.35
232012	Steel Bracket, 12" Anochrome	SC43 HA26 SH7		Steel	6.26	6.26	6.26	6.26	6.26
232014	Steel Bracket, 14" Anochrome	SC43 HA26 SH7		Steel	7.43	7.43	7.43	7.43	7.43
232016	Steel Bracket, 16" Anochrome	SC43 HA26 SH7		Steel	7.96	7.96	7.96	7.96	7.96
232023	Slotted Steel Standard, 3 ft.	SC16 HA26 SH7		Plated Steel	7.85	7.85	7.85	7.85	7.85
232028	Slotted Steel Standard, 8 ft.	SC16 HA26 SH7		Plated Steel	14.42	14.42	14.42	14.42	14.42
232045	135° Rectangular Glass Clip for 3/8" & 1/2" glass	G20		Buffed or Brushed	27.61	26.51	25.95	24.85	24.30
232056	Alu Clip	G23		Cast Zinc	4.51	4.51	4.51	4.51	4.51
241001-01 241001-03	Endcap for 190023, Plastic (01) Black, (03) Grey	G25		Plastic	0.96	0.96	0.96	0.96	0.84

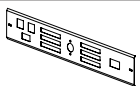
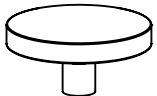

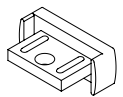
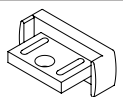
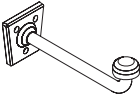
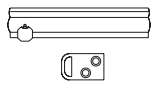
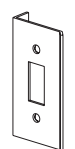



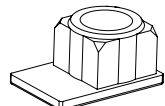

Part Number	Description	Cat. Page Ref.	View	Finish	Discount Quantity Pricing				
					1-5	6-10	11-24	25-99	100+
241003-01	Endcap for 190042, Plastic (01) Black			Plastic	0.96	0.96	0.96	0.96	0.84
241004-01 241004-03	Endcap for 190026, Plastic (01) Black, (03) Grey	G25		Plastic	2.00	2.00	2.00	2.00	1.76
241009	Cap for Aluclip (#232056)			Plastic	0.09	0.09	0.09	0.09	0.09
241014-01	Endcap for 190014, Plastic (01) Black	G25		Plastic	0.96	0.96	0.96	0.96	0.84
241015-01 241015-03	Endcap, .995", Square (01) Black, (03) Grey	G25		Plastic	0.96	0.96	0.96	0.96	0.84
241038-01	Endcap for 190022, Plastic (01) Black			Plastic	0.96	0.96	0.96	0.96	0.84
310052	Retaining Ring for 511040			Carbon Spring Steel	0.80	0.77	0.75	0.74	0.70
310079	Ballast Box Cover	SC33		Black	6.64	6.37	6.24	6.11	5.84
310080	Ballast Box Tray	SC32		Galvanized Steel	2.65	2.54	2.49	2.44	2.33
310085	Ballast Box Insert Tray for Double Ballast Box	SC33		Galvanized Steel	6.58	6.32	6.19	6.05	5.79
310124	90° Connector for 230056 (No UL Listing / Recognition on connector)	SC29		Black	0.99	0.95	0.93	0.91	0.87
310130	Hinge Pin	S8		Zinc Plated	5.93	5.69	5.57	5.46	5.22
310204	Endcap for 110200	AT8		Buffed or Brushed	11.23	10.78	10.56	10.33	9.88
310205	Endcap for 110201 and 110295	AT8		Buffed or Brushed	10.22	9.81	9.61	9.40	8.99

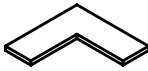



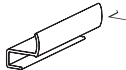
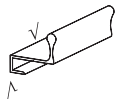

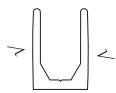

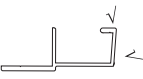
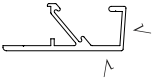

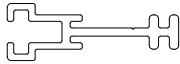

Part Number	Description	Cat. Page Ref.	View	Finish	Discount Quantity Pricing				
					1-5	6-10	11-24	25-99	100+
310206	Endcap for 110202	AT8		Buffed or Brushed	10.99	10.55	10.33	10.11	9.67
310207	Endcap for 110210	AT8		Buffed or Brushed	11.86	11.39	11.15	10.91	10.44
310209	Endcap for 110212	AT8		Buffed or Brushed	11.68	11.21	10.98	10.75	10.28
310210	Endcap for 110214 - RH (LH-310211)	AT14		Buffed or Brushed	17.07	16.39	16.05	15.70	15.02
310211	Endcap for 110214 - LH (RH - 310210)	AT14		Buffed or Brushed	17.07	16.39	16.05	15.70	15.02
310212	Endcap for 110223	AT11		Buffed or Brushed	9.29	8.92	8.73	8.55	8.18
310213	Endcap for 110225	AT11		Buffed or Brushed	11.13	10.68	10.46	10.24	9.79
310214	Endcap for 110226	AT11		Buffed or Brushed	12.15	11.66	11.42	11.18	10.69
310215	Endcap for 110227	AT11		Buffed or Brushed	16.23	15.58	15.26	14.93	14.28
310218	Endcap for 110232	AT14		Buffed or Brushed	13.03	12.51	12.25	11.99	11.47
310219	Endcap for 110233	AT14		Buffed or Brushed	22.14	21.25	20.81	20.37	19.48
310227	Endcap for 110244 - LH (RH 310228)	AT14		Buffed or Brushed	17.52	16.82	16.47	16.12	15.42
310228	Endcap for 110244 - RH (LH 310227)	AT14		Buffed or Brushed	17.52	16.82	16.47	16.12	15.42
310229	Endcap for 110245			Buffed or Brushed	11.22	10.77	10.55	10.32	9.87
310233	Endcap for 110260	AT14		Buffed or Brushed	11.41	10.95	10.73	10.50	10.04
310235	Endcap for 110269	AT11		Buffed or Brushed	13.93	13.37	13.09	12.82	12.26
310239	Endcap for 110286 - RH (LH 310242)	AT6		Buffed or Brushed	15.48	14.86	14.55	14.24	13.62
310240	Endcap for 110290 - RH (LH 310243)	AT6		Buffed or Brushed	12.51	12.01	11.76	11.51	11.01

Part Number	Description	Cat. Page Ref.	View	Finish	Discount Quantity Pricing				
					1-5	6-10	11-24	25-99	100+
310241	Endcap for 110294	AT11		Buffed or Brushed	22.79	21.88	21.42	20.97	20.06
310242	Endcap for 110286 - LH (RH 310239)	AT6		Buffed or Brushed	15.48	14.86	14.55	14.24	13.62
310243	Endcap for 110290 - LH (RH 310240)	AT6		Buffed or Brushed	12.51	12.01	11.76	11.51	11.01
310244	Endcap for 110299 - RH (LH 310245)	AT6		Buffed or Brushed	13.27	12.74	12.47	12.21	11.68
310245	Endcap for 110299 - LH (RH 310244)	AT6		Buffed or Brushed	13.27	12.74	12.47	12.21	11.68
310249	Endcap for 110310	AT8		Buffed or Brushed	15.18	14.57	14.27	13.97	13.36
310250	Endcap, Rectangular for 110307	AT11		Buffed or Brushed	8.92	8.56	8.38	8.21	7.85
310251	Endcap for 110304	AT9		Buffed or Brushed	14.27	13.70	13.41	13.13	12.56
310252	Endcap for 110308 - RH (LH 310253)	AT6		Buffed or Brushed	9.85	9.46	9.26	9.06	8.67
310253	Endcap for 110308 - LH (RH 310252)	AT6		Buffed or Brushed	9.85	9.46	9.26	9.06	8.67
310259	Endcap for 110325 - LH (RH 310260)	AT14		Buffed or Brushed	15.57	14.95	14.64	14.32	13.70
310260	Endcap for 110325 - RH (LH 310259)	AT14		Buffed or Brushed	15.57	14.95	14.64	14.32	13.70
310286	Endcap for 110381	AT14		Buffed or Brushed	16.02	15.38	15.06	14.74	14.10
310287	Endcap for 110382 - LH (RH 310288)	AT14		Buffed or Brushed	11.97	11.49	11.25	11.01	10.53
310288	Endcap for 110382 - RH (LH 310287)	AT14		Buffed or Brushed	11.97	11.49	11.25	11.01	10.53
310292	Endcap for 110383 - LH (RH 310293)	AT15		Buffed or Brushed	13.89	13.33	13.06	12.78	12.22
310293	Endcap for 110383 - RH (LH 310292)	AT15		Buffed or Brushed	13.89	13.33	13.06	12.78	12.22
310323	Endcap for 110328	AT8		Buffed or Brushed	6.44	6.18	6.05	5.92	5.67

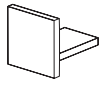



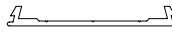
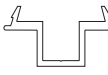
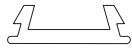









Part Number	Description	Cat. Page Ref.	View	Finish	Discount Quantity Pricing				
					1-5	6-10	11-24	25-99	100+
310324	Endcap for 110432 - LH (RH 310325)			Buffed or Brushed	7.90	7.58	7.43	7.27	6.95
310325	Endcap for 110432 - RH (LH 310324)			Buffed or Brushed	7.90	7.58	7.43	7.27	6.95
310342	WallMaker Vertical Bracket			Non-Buffed Non-Brushed	3.22	3.09	3.03	2.96	2.83
310351	1-1/4" Piano Hinge w/Unequal Legs (without holes) 8 ft.	HA34 S15		Non-Buffed Non-Brushed	16.28	15.63	15.30	14.98	14.33
310354-01	90° Corner Bracket	G4		Zinc	29.07	27.91	27.33	26.74	25.58
310354-02	135° Corner Bracket	G4		Zinc	75.00	72.00	70.50	69.00	66.00
310354-03	120° Corner Bracket	G4		Zinc	31.82	30.55	29.91	29.27	28.00
310374	Endcap for 110296 - LH (RH 310375)	AT6		Buffed or Brushed	8.83	8.48	8.30	8.12	7.77
310375	Endcap for 110296 - RH (LH 310374)	AT6		Buffed or Brushed	8.83	8.48	8.30	8.12	7.77
310377	Endcap for 110420 - RH (LH 310378)	AT15		Buffed or Brushed	17.58	16.88	16.53	16.17	15.47
310378	Endcap for 110420 - LH (RH 310377)	AT15		Buffed or Brushed	17.58	16.88	16.53	16.17	15.47
310385	Endcap for 110400 - RH (LH 310386)			Buffed or Brushed	13.23	12.70	12.44	12.17	11.64
310386	Endcap for 110400 - LH (RH 310385)			Buffed or Brushed	13.23	12.70	12.44	12.17	11.64
310395	Endcap for 110267	AT8		Buffed or Brushed	16.49	15.83	15.50	15.17	14.51
310399	Endcap for 110465 - LH (RH 310400)	AT15		Buffed or Brushed	21.86	20.99	20.55	20.11	19.24
310400	Endcap for 110465 - RH (LH 310399)	AT15		Buffed or Brushed	21.86	20.99	20.55	20.11	19.24







Part Number	Description	Cat. Page Ref.	View	Finish	Discount Quantity Pricing				
					1-5	6-10	11-24	25-99	100+
310403	Endcap for 110410	AT11		Buffed or Brushed	19.53	18.75	18.36	17.97	17.19
310577	Ballast Box Cover	SC33			6.01	5.77	5.65	5.53	5.29
310614	Endcap, Round Threaded			Non-Buffered Non-Brushed	8.33	8.00	7.83	7.66	7.33
310735	Endcap for 110639	AT11		Buffed or Brushed	12.74	12.23	11.98	11.72	11.21
330017-01	Unflocked Top Guide			Black Nylon	0.31	0.30	0.29	0.29	0.27
330017-02	Flocked Top Guide	RD17		Black Nylon	2.86	2.75	2.69	2.63	2.52
370006	SteelCoat Hook	FM4		Zinc	12.60	12.10	11.84	11.59	11.09
370008	Chrome Door Latch	FM4		Satin Chrome	18.89	18.13	17.76	17.38	16.62
370012	Strike Plate	FM4		Zinc	3.92	3.76	3.68	3.61	3.45
370013	Shoulder Screw			Zinc	0.26	0.25	0.24	0.24	0.23
380269	Endcap for 6815xx Series Reflector Assemblies	SS24		Buffed or Brushed	12.01	11.53	11.29	11.05	10.57
380270	LED 1-1/2" Reflector Mount Bracket (180079 Reflector)	SC29			4.94	4.74	4.64	4.54	4.35
380697	Anchor, Rotating Downtube Connector	SC23		Non-Buffered Non-Brushed	9.88	9.48	9.29	9.09	8.69
390031-01 390031-03	Endcap for 190019, Plastic (01) Black, (03) Grey"	G25		Plastic	0.53	0.51	0.50	0.49	0.47
391501	Spring, 1-3/8" PrintFrame, 1.410 Dia. SST			Stainless Steel	0.26	0.25	0.24	0.24	0.23

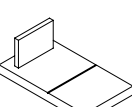

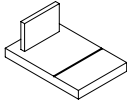
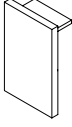
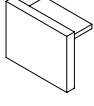

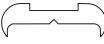
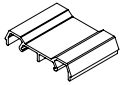
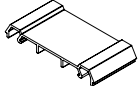

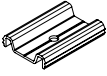

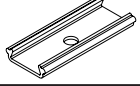
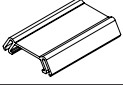
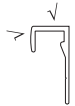
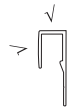

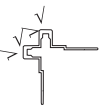

Part Number	Description	Cat. Page Ref.	View	Finish	Discount Quantity Pricing				
					1-5	6-10	11-24	25-99	100+
391505	Corner Bracket Plate			Galvanized Steel	1.34	1.29	1.26	1.23	1.18
391548	Spring, 1" PrintFrame, 0.940 Dia. SST			Stainless Steel	0.26	0.25	0.24	0.24	0.23
391551	Corner Gusset, 1" PrintFrame			Galvanized Steel	1.04	1.00	0.98	0.96	0.92
391553	Corner Gusset, 1-3/8" PrintFrame			Galvanized Steel	1.56	1.50	1.47	1.44	1.37
391997	Slatwall Hanger for PrintFrame				6.88	6.60	6.47	6.33	6.05
410001	2-3/4" Door Pull (110027 - 12 ft.)	HA23		Non-Buffered Non-Brushed	5.51	5.29	5.18	5.07	4.85
				Buffered or Brushed	6.61	6.35	6.21	6.08	5.82
410002	2-3/4" Door Pull (110029 - 12 ft.)	HA23		Non-Buffered Non-Brushed	5.51	5.29	5.18	5.07	4.85
				Buffered or Brushed	6.61	6.35	6.21	6.08	5.82
410050	1/2" Downtube 3/8" I.D. (36" length)	SC29		Non-Buffered Non-Brushed	5.27	5.06	4.95	4.85	4.64
410099	Showcase Molding with Holes, 12 ft. (without holes 110577)	SC15		Non-Buffered Non-Brushed	19.35	18.58	18.19	17.80	17.03
				Buffered or Brushed	21.04	20.20	19.78	19.36	18.52
410101	Drawer Pull, 3-3/4" (for 3/4" Drawer) (110104 - 12 ft.)	HA23		Non-Buffered Non-Brushed	6.34	6.09	5.96	5.83	5.58
				Buffered or Brushed	7.44	7.14	6.99	6.84	6.55
410103	Drawer Pull, 3-3/4" (for 13/16" Drawer) (110105 - 12 ft.)	HA23		Non-Buffered Non-Brushed	5.51	5.29	5.18	5.07	4.85
				Buffered or Brushed	6.61	6.35	6.21	6.08	5.82
410114	3-3/4" Drawer Pull (110108 - 12 ft.)	HA23		Non-Buffered Non-Brushed	6.06	5.82	5.70	5.58	5.33
				Buffered or Brushed	7.17	6.88	6.74	6.60	6.31
410123	3-3/4" Drawer Pull with Label Holder (110111 - 12 ft.)	HA23		Non-Buffered Non-Brushed	6.34	6.09	5.96	5.83	5.58
				Buffered or Brushed	7.44	7.14	6.99	6.84	6.55



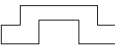

Part Number	Description	Cat. Page Ref.	View	Finish	Discount Quantity Pricing				
					1-5	6-10	11-24	25-99	100+
410311	2" Hinge Plate	S15		Non-Buffered Non-Brushed	5.51	5.29	5.18	5.07	4.85
				Buffered or Brushed	8.97	8.61	8.43	8.25	7.89
410312	Hinge Plate with Holes, 12 ft.			Non-Buffered Non-Brushed	67.63	64.92	63.57	62.22	59.51
				Buffered or Brushed	71.84	68.97	67.53	66.09	63.22
410366	1/8" Endcap for 110483 (2"x 1-3/4" Header)	G5		Buffered or Brushed	8.02	7.70	7.54	7.38	7.06
410367	1/8" Endcap for 110482 (2"x4" Sill)	G5		Buffered or Brushed	9.34	8.97	8.78	8.59	8.22
410381	Security Door Retainer (use with 110140, 110350 or 110412 shoe)	RD15		Non-Buffered Non-Brushed	1.31	1.26	1.23	1.21	1.15
410412	1/8" Encap for 110360, 111012 or 111013 (1"x2" Header)	G5		Buffered or Brushed	11.46	11.00	10.77	10.54	10.08
410413	1/8" Endcap for 110361 (1"x1" Sill)	G5		Buffered or Brushed	11.45	10.99	10.76	10.53	10.08
410443	1" Trim Base with Holes, 12 ft.	AT16		Non-Buffered Non-Brushed	19.02	18.26	17.88	17.50	16.74
410444	Security Door Retainer (use with 110012 Shoe)	RD15		Non-Buffered Non-Brushed	1.66	1.59	1.56	1.53	1.46
410454	1-7/8" Security Door Retainer	RD15		Non-Buffered Non-Brushed	2.59	2.49	2.43	2.38	2.28
410458	3" Trim Base, 12 ft.	AT16		Non-Buffered Non-Brushed	45.94	44.10	43.18	42.26	40.43
410466	1" Recessed Trim Base, 12 ft.	AT16		Non-Buffered Non-Brushed	37.68	36.17	35.42	34.67	33.16
410530	5/8" Trim Base with Holes, 12 ft.	AT16		Non-Buffered Non-Brushed	21.66	20.79	20.36	19.93	19.06
410540	2" Trim Base with Holes, 12 ft.	AT16		Non-Buffered Non-Brushed	33.35	32.02	31.35	30.68	29.35

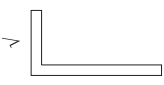
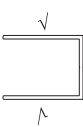









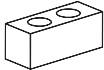
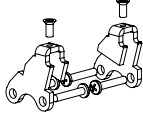

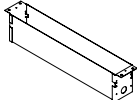
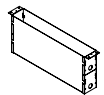



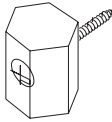
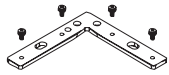
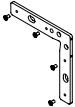

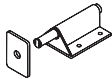



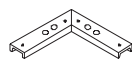

Part Number	Description	Cat. Page Ref.	View	Finish	Discount Quantity Pricing				
					1-5	6-10	11-24	25-99	100+
410542	1/2" Endcap for 110483 (2"x1-3/4" Header)	G7		Buffed or Brushed	17.66	16.95	16.60	16.25	15.54
410543	1/2" Endcap for 110482 (2"x4" Sill)	G7		Buffed or Brushed	22.63	21.72	21.27	20.82	19.91
410544	1/2" Endcap for 110481 (2"x6" Sill)	G7		Buffed or Brushed	24.90	23.90	23.41	22.91	21.91
410545	1/8" Endcap for 110481 (2"x6" Sill)	G7		Buffed or Brushed	15.90	15.26	14.95	14.63	13.99
410644	3" Recessed Trim Base with Holes, 12 ft.	AT16		Non-Buffed Non-Brushed	48.67	46.72	45.75	44.78	42.83
410896	1/8" Endcap for 110434 (2-1/2"x1-3/4" Sill)	G7		Buffed or Brushed	10.81	10.38	10.16	9.95	9.51
411185	5/8" Recessed Trim Base, 12 ft.	AT16		Non-Buffed Non-Brushed	30.95	29.71	29.09	28.47	27.24
411331	3/4" Trim Base with Holes for Endcap, 12 ft.	AT17		Non-Buffed Non-Brushed	14.25	13.68	13.40	13.11	12.54
412002	4.50" Trim Base, 145.50"	AT17		Non-Buffed Non-Brushed	75.43	72.41	70.90	69.40	66.38
412007	5/8" Trim Base with Mounting Holes, 145.50"	AT17		Non-Buffed Non-Brushed	17.38	16.68	16.34	15.99	15.29
412272	3" Trim Base with Mount Holes, 12 ft.	AT17		Non-Buffed Non-Brushed	46.73	44.86	43.93	42.99	41.12
412434	1/8" Endcap for 111007 (2"x8" Sill)	G5		Buffed or Brushed	22.05	21.17	20.73	20.29	19.40
412435	1/8" Endcap for 111011 (2-1/2"x 8" Sill)	G5		Buffed or Brushed	22.05	21.17	20.73	20.29	19.40
412436	1/8" Endcap for 111014 (2-1/2"x 6" Sill)	G5		Buffed or Brushed	19.29	18.52	18.13	17.75	16.98
412437	1/8" Endcap for 111015 (2-1/2"x 4" Sill)	G5		Buffed or Brushed	15.71	15.08	14.77	14.45	13.82
412443	Endcap for 111010 Top Channel			Buffed or Brushed	13.23	12.70	12.44	12.17	11.64



Part Number	Description	Cat. Page Ref.	View	Finish	Discount Quantity Pricing				
					1-5	6-10	11-24	25-99	100+
412444	Endcap for 111072 Top Channel			Buffed or Brushed	13.23	12.70	12.44	12.17	11.64
412456	Endcap for 111089 Top Channel			Buffed or Brushed	12.13	11.64	11.40	11.16	10.67
412457	Endcap for 111091 Top Channel			Buffed or Brushed	12.13	11.64	11.40	11.16	10.67
419007	Top Guide	RD15		Non-Buffed Non-Brushed	0.16	0.15	0.15	0.15	0.14
419020	1" Piano Hinge with Holes, 8 ft.	HA34		Non-Buffed Non-Brushed	27.93	26.81	26.25	25.70	24.58
419030	Vinyl Door Guide (use rivet 222012 - sold separately)	RD15		Non-Buffed Non-Brushed	0.38	0.36	0.36	0.35	0.33
419070	Plastic Snap Base Clip (green) for TrimMaker Extrusion with 2" Openings	AT18		Green Plastic	1.06	1.02	1.00	0.98	0.93
419071	Plastic Snap Base Clip (yellow) for TrimMaker Extrusion with 3" Openings	AT18		Yellow Plastic	1.06	1.02	1.00	0.98	0.93
419072	Plastic Snap Base Clip (orange) for TrimMaker Extrusion with 4.5" Openings	AT18		Orange Plastic	1.22	1.17	1.15	1.12	1.07
419073	Plastic Snap Base Clip (black) for TrimMaker Extrusion with 1" Openings	AT18		Black Plastic	1.22	1.17	1.15	1.12	1.07
419074	Plastic Snap Base Clip (grey) for TrimMaker Extrusion with 5/8" Openings	AT18		Grey Plastic	1.33	1.28	1.25	1.22	1.17
419076	Plastic Snap Base Clip (red) for TrimMaker Extrusion with 5/8" Openings	AT18		Red Plastic	1.33	1.28	1.25	1.22	1.17
419077	Plastic Snap Base Clip (blue) for TrimMaker Extrusion with 1" Openings	AT18		Blue Plastic	1.06	1.02	1.00	0.98	0.93
420068	5/16" J-Molding with Holes, 12 ft. (without Holes - 120041)	FM15		Non-Buffed Non-Brushed	14.45	13.87	13.58	13.29	12.72
				Buffed or Brushed	21.13	20.28	19.86	19.44	18.59
420107	5/8" J-Molding with Holes, 12 ft. (without Holes - 120055)	FM15		Non-Buffed Non-Brushed	17.87	17.16	16.80	16.44	15.73
				Buffed or Brushed	23.74	22.79	22.32	21.84	20.89



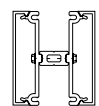
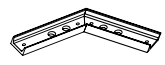

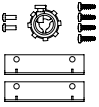
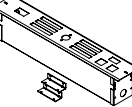

Part Number	Description	Cat. Page Ref.	View	Finish	Discount Quantity Pricing				
					1-5	6-10	11-24	25-99	100+
420108	Mirror Divider Trim with Holes, 12 ft. (without holes 120057)	FM15		Non-Buffered Non-Brushed	19.11	18.35	17.96	17.58	16.82
				Buffered or Brushed	23.96	23.00	22.52	22.04	21.08
420109	Mirror Divider Trim with Holes, 12 ft. (without holes 120061)	FM15		Non-Buffered Non-Brushed	29.07	27.91	27.33	26.74	25.58
				Buffered or Brushed	32.56	31.26	30.61	29.96	28.65
420110	Slotted Corner Column, 150" (without slots 120063)	FM16		Non-Buffered Non-Brushed	59.12	56.76	55.57	54.39	52.03
				Buffered or Brushed	64.42	61.84	60.55	59.27	56.69
429004	1/4" Glazing Wedge	FM14		Black	0.71	0.68	0.67	0.65	0.62
429007	Glazing Clip	FM14		Grey	0.87	0.84	0.82	0.80	0.77
450010	Aluminum Showcase Slotted Standard	HA24 SC16 SH5		Price per Inch / Cutting charge also applies	0.60	0.60	0.60	0.60	0.59
450013	Aluminum Slotted Wall Standard	HA24 SH7		Price per Inch / Cutting charge also applies	0.80	0.80	0.80	0.80	0.78
450020	Aluminum Showcase Heavy Duty Slotted Standard	HA25 SC19 SH6		Price per Inch / Cutting charge also applies	0.72	0.72	0.72	0.72	0.71
450021	Aluminum Rear Support for 450020	HA25 SC16 SH6		Price per Inch / Cutting charge also applies	0.33	0.33	0.33	0.33	0.32
450022	Aluminum Rear Support for 450010	SH7 HA24 SC10		Price per Inch / Cutting charge also applies	0.40	0.40	0.40	0.40	0.39
450023	Aluminum Heavy Duty Slotted Standard, 12 ft.				61.72	59.25	58.02	56.78	54.31
470010	Door Jamb, 7 ft.	F2		Non-Buffered Non-Brushed	27.84	26.73	26.17	25.61	24.50
				Buffered or Brushed	34.34	32.97	32.28	31.59	30.22
470012	Wall Jamb with Holes, 12 ft. (without holes 170008)	F2		Non-Buffered Non-Brushed	35.82	34.39	33.67	32.95	31.52
				Buffered or Brushed	49.25	47.28	46.30	45.31	43.34
480753	3/8" Threaded Washer 1" O.D.	SC30		Non-Buffered Non-Brushed	6.71	6.44	6.31	6.17	5.90

Part Number	Description	Cat. Page Ref.	View	Finish	Discount Quantity Pricing				
					1-5	6-10	11-24	25-99	100+
480756	Support Puck	SC30		Non-Buffered Non-Brushed	5.59	5.37	5.25	5.14	4.92
480757	3/8" Downtube 9/32" I.D.	SC30		Non-Buffered Non-Brushed	5.96	5.72	5.60	5.48	5.24
480941	7/16" Downtube 9/32" I.D.	SC30		Non-Buffered Non-Brushed	14.91	14.31	14.02	13.72	13.12
480943	7/16" Threaded Washer 1-1/4" O.D.	SC30		Non-Buffered Non-Brushed	6.71	6.44	6.31	6.17	5.90
480989	Endcap, 1.00 Dia Reflector 180133	SC25		Buffered or Brushed	17.91	17.19	16.84	16.48	15.76
480993	Connector, Downtube, 1.00 Dia. Reflector	SC25		Non-Buffered Non-Brushed	9.92	9.52	9.32	9.13	8.73
481042	Connector, Downtube Internal Rotating for 180133 1.00 Dia. Reflector	SC25		Non-Buffered Non-Brushed	23.30	22.37	21.90	21.44	20.50
481056	Endcap, RH Teardrop Reflector 180147	SC23		Buffered or Brushed	11.58	11.12	10.89	10.65	10.19
481057	Endcap, LH Teardrop Reflector 180147	SC23		Buffered or Brushed	11.58	11.12	10.89	10.65	10.19
490257	Double-Sided Cornerpiece			Non-Buffered Non-Brushed	21.20	20.35	19.93	19.50	18.66
510001	Wheel Assembly for 110012 (wheel code W1)	RD15			0.92	0.88	0.86	0.85	0.81
510006	Door Bumper Assembly	RD15			0.78	0.75	0.73	0.72	0.69
510014	1/2" Heavy Duty Door Stop Assembly	RD15			2.86	2.75	2.69	2.63	2.52
510015	3/4" Heavy Duty Door Stop Assembly	RD15			3.12	3.00	2.93	2.87	2.75
510016-02	Standard Door Pull Assembly, Natural	HA23		Natural	6.55	6.29	6.16	6.03	5.76
510016-03	Standard Door Pull Assembly, Black	HA23		Black	8.35	8.02	7.85	7.68	7.35
510041	Heavy Duty Wheel Assembly (wheel code W5)	RD15			1.05	1.01	0.99	0.97	0.92

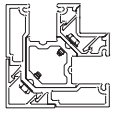
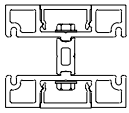



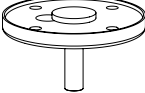
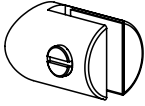
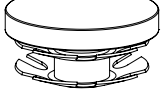







Part Number	Description	Cat. Page Ref.	View	Finish	Discount Quantity Pricing				
					1-5	6-10	11-24	25-99	100+
510060	Heavy Duty Door Stop Assembly, 1/2"	RD15			2.86	2.75	2.69	2.63	2.52
510073	Mount Bracket Kit	SC30			6.24	5.99	5.87	5.74	5.49
510089	Mounting Bracket Assembly for 110107/110192	HA21 SC16			9.00	8.64	8.46	8.28	7.92
510101	Single Ballast Box	SC34		Aluminized Steel	18.20	17.47	17.11	16.74	16.02
510102	Double Ballast Box	SC35		Aluminized Steel	30.35	29.14	28.53	27.92	26.71
510126	90° Reflector Mitre Bracket Assembly	HA21			6.20	5.95	5.83	5.70	5.46
510127	135° Reflector Mitre Bracket Assembly	HA21			6.20	5.95	5.83	5.70	5.46
510199-01	Chrome Cam Lock used with 110153 hinged door frame extrusion. 7/8" cam length, key retaining. Includes 2 keys. (Kenstan CLD03-type)	HA22 S15		Chrome	16.80	16.13	15.79	15.46	14.78
510199-02	Chrome Cam Lock used with 110153 hinged door frame extrusion. 7/8" cam length, key retaining. Includes 6 keys. (Kenstan CLD03-type)	HA22 S15		Chrome	20.88	20.04	19.63	19.21	18.37
510235	Hex Shelf Support Assembly	SC10			3.22	3.09	3.03	2.96	2.83
510237	Corner Bracket Assembly for Transparency Frame	S15 HA21			9.10	8.74	8.55	8.37	8.01
510238	Corner Bracket Assembly for Hinged Door	S15 HA21			9.10	8.74	8.55	8.37	8.01
510241	Endcap Assembly for 110140	RD15		Non-Buffered Non-Brushed	6.71	6.44	6.31	6.17	5.90
510245	Magnetic Latch and Strike Assembly	HA22			4.00	3.84	3.76	3.68	3.52







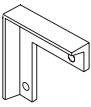
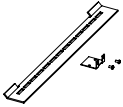

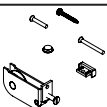
Part Number	Description	Cat. Page Ref.	View	Finish	Discount Quantity Pricing				
					1-5	6-10	11-24	25-99	100+
510246	Corner Bracket / Back Place Assembly for Transparence Face Frame Assembly	HA21			2.60	2.50	2.44	2.39	2.29
510249	Chrome Offset Cam Lock used with #710000 Series Showcase top or bottom hinged door. 7/8" cam w/ 1/4" offset, key retaining. Includes 2 keys. (Kenstan CLD03-type)	HA22		Chrome	16.33	15.68	15.35	15.02	14.37
510269	Chrome L-Cam Lock used with #710000 Series Showcase side hinged door. 5/8" cam w/ 1/2" L-bend, key retaining. Includes 2 keys. (Kenstan CLD03-type)	HA22		Chrome	17.97	17.25	16.89	16.53	15.81
510274	90° WallMaker Bracket Assembly	G4			37.44	35.94	35.19	34.44	32.95
510331	Endcap Assembly for 110350	RD15		Non-Buffered Non-Brushed	4.72	4.53	4.44	4.34	4.15
510349	Mini Latch Assembly	S15 HA22			21.01	20.17	19.75	19.33	18.49
510371	Edcap Assembly for 110412	RD15		Non-Buffered Non-Brushed	8.32	7.99	7.82	7.65	7.32
510378	Downtube Flange	SC30			14.87	14.28	13.98	13.68	13.09
510440	135° WallMaker Bracket Assembly	G4			80.00	76.80	75.20	73.60	70.40
510458	WallMaker "T" Bracket Assembly Kit	G4			8.34	8.01	7.84	7.67	7.34
510459	WallMaker "L" Bracket Assembly Kit	G4			5.17	4.96	4.86	4.76	4.55
510529	WallMaker Smooth H-Assembly	G3		Non-Buffered Non-Brushed	182.68	175.37	171.72	168.07	160.76
				Buffered or Brushed	203.68	195.53	191.46	187.39	179.24
510540	120° WallMaker Bracket Assembly	G4			53.04	50.92	49.86	48.80	46.68
510571	180° Square Glass Clip for 3/8" & 1/2" glass	G19		Buffered or Brushed	27.34	26.25	25.70	25.15	24.06
510572	180° Round Glass Clip for 3/8" & 1/2" glass	G17		Buffered or Brushed	26.42	25.36	24.83	24.31	23.25

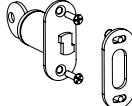
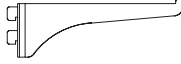
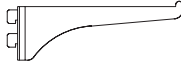
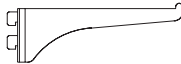

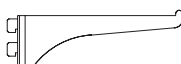

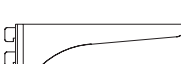
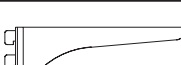

Part Number	Description	Cat. Page Ref.	View	Finish	Discount Quantity Pricing				
					1-5	6-10	11-24	25-99	100+
510582	Round, Wall Mount Glass Clip for 3/8" & 1/2" glass	G18		Buffed or Brushed	25.68	24.65	24.14	23.63	22.60
510583	Square, Wall Mount Glass Clip for 3/8" & 1/2" glass	G19		Buffed or Brushed	20.32	19.51	19.10	18.69	17.88
510584	90° Round Glass Clip for 3/8" & 1/2" glass	G18		Buffed or Brushed	40.32	38.71	37.90	37.09	35.48
510585	90° Square Glass Clip for 3/8" & 1/2" glass	G19		Buffed or Brushed	32.36	31.07	30.42	29.77	28.48
510586	135° Round Glass Clip for 3/8" & 1/2" glass	G18		Buffed or Brushed	42.74	41.03	40.18	39.32	37.61
510587	135° Square Glass Clip for 3/8" & 1/2" glass	G19		Buffed or Brushed	26.36	25.31	24.78	24.25	23.20
510598	Ballast Box Accessory Kit (Screws, 12 and 18 Gauge Terminal Connector, Rocker Switch, Ballast Box Bracket and Knock-out Connector)	SC32			5.77	5.54	5.42	5.31	5.08
510599	Single Ballast Box Kit (Screws, Palnuts and Single Ballast Box Cover and Tray)	SC32		Black	29.68	28.49	27.90	27.31	26.12
510600	Single Ballast Box Kit with Accessories	SC33			27.79	26.68	26.12	25.57	24.46
510621	Flex Connector 3/8" I.D. Conduit	SC30			4.06	3.90	3.82	3.74	3.57
510622	Rigid Connector 1/2" Downtube	SC30			4.39	4.21	4.13	4.04	3.86
510625	Double Ballast Box Kit (Screws, Palnuts and Double Ballast Box Cover and Tray)	SC33			51.64	49.57	48.54	47.51	45.44
510626	Double Ballast Box with Accessories	SC33			60.65	58.22	57.01	55.80	53.37
510760	WallMaker Wireway Assembly	G3		Non-Buffered Non-Brushed	288.33	241.54	236.51	231.48	221.41
				Buffed or Brushed	317.33	241.54	236.51	231.48	221.41

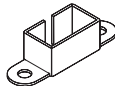

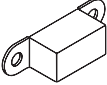
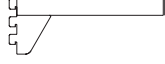
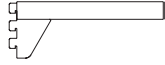
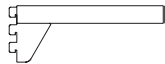
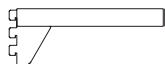
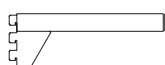
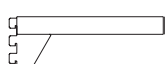

Part Number	Description	Cat. Page Ref.	View	Finish	Discount Quantity Pricing				
					1-5	6-10	11-24	25-99	100+
510761	WallMaker 90° Corner Assembly	G3		Non-Buffered Non-Brushed	342.04	328.36	321.52	314.68	301.00
				Buffered or Brushed	362.63	348.12	340.87	333.62	319.11
510763	WallMaker H-Assembly	G3		Non-Buffered Non-Brushed	233.42	224.08	219.41	214.75	205.41
				Buffered or Brushed	253.01	242.89	237.83	232.77	222.65
510808	Chrome Plunger Lock used with 110140, 110350 & 110412 rolling door shoe extrusions. 3/8" length plunger, key retaining. Includes 2 keys. (Kenstan PLD40-type)	RD15 HA22 SC5		Chrome	24.77	23.78	23.28	22.79	21.80
510955	180° Rectangular Glass Clip for 3/8" & 1/2" glass	G20		Buffered or Brushed	27.62	26.52	25.96	25.41	24.31
511008	90° Rectangular Glass Clip for 3/8" & 1/2" glass	G20		Buffered or Brushed	30.84	29.61	28.99	28.37	27.14
511040	Chrome Plunger Lock used with 110012 & 110067 rolling door shoe extrusions. Through-the-track plunger, key retaining. Includes 2 keys. (Kenstan PLD49-type)	HA22 SC9 RD15		Steel Chrome Plated	27.29	26.20	25.65	25.11	24.02
511070	Kit Strut Fixing Mounting Base			Non-Buffered Non-Brushed	13.85	13.30	13.02	12.74	12.19
511079	Kit, Bracket 1.0 Dia., Vertical Glass Clamp			Non-Buffered Non-Brushed	25.95	24.91	24.39	23.87	22.84
511085	Kit, End Piece w/Insert			Non-Buffered Non-Brushed	11.50	11.04	10.81	10.58	10.12
511069	Kit, Support Fixing 90 Degree Mounting Flange				26.00	24.96	24.44	23.92	22.88
511178	Top Shoe Guide Assembly	RD15 SC15			4.16	3.99	3.91	3.83	3.66
511179	90° Round Glass Clip for 5/8" & 3/4" glass	G18		Buffered or Brushed	39.88	38.28	37.49	36.69	35.09

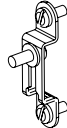

Part Number	Description	Cat. Page Ref.	View	Finish	Discount Quantity Pricing				
					1-5	6-10	11-24	25-99	100+
511180	135° Round Glass Clip for 5/8" & 3/4" glass	G18		Buffed or Brushed	42.85	41.14	40.28	39.42	37.71
511181	180° Round Glass Clip for 5/8" & 3/4" glass	G17		Buffed or Brushed	26.24	25.19	24.67	24.14	23.09
511182	Round, Wall Mount Glass Clip for 5/8" & 3/4" glass	G18		Buffed or Brushed	24.09	23.13	22.64	22.16	21.20
511183	135° Rectangular Glass Clip for 5/8" & 3/4" glass	G21		Buffed or Brushed	27.09	26.01	25.46	24.92	23.84
511184	180° Rectangular Glass Clip for 5/8" & 3/4" glass	G20		Buffed or Brushed	30.04	28.84	28.24	27.64	26.44
511185	90° Rectangular Glass Clip for 5/8" & 3/4" glass	G20		Buffed or Brushed	29.70	28.51	27.92	27.32	26.14
511186	90° Square Glass Clip for 5/8" & 3/4" glass	G19		Buffed or Brushed	29.75	28.56	27.97	27.37	26.18
511187	135° Square Glass Clip for 5/8" & 3/4" glass	G19		Buffed or Brushed	26.40	25.34	24.82	24.29	23.23
511188	180° Square Glass Clip for 5/8" & 3/4" glass	G19		Buffed or Brushed	25.91	24.87	24.36	23.84	22.80
511189	Square, Wall Mount Glass Clip for 5/8" & 3/4" glass	G19		Buffed or Brushed	20.45	19.63	19.22	18.81	18.00
511213	Kit, AXIA,50 pieces of Intermediate connector, 4" each	AT20			78.75	78.75	78.75	78.75	78.75
511215	Kit, AXIA , 10 pieces each of Starter/ End connectors, 4" each	AT20			39.90	39.90	39.90	39.90	39.90
520005	Mitre Bracket Assembly	HA21 FM14			1.55	1.49	1.46	1.43	1.36
520075	Cleat Mounting Accessory Kit for Admire LED Mirror				19.76	18.97	18.57	18.18	17.39
530011	Wheel Assembly	RD17			18.36	17.63	17.26	16.89	16.16
530012	Decor Door Accessory Package				86.98	83.50	81.76	80.02	76.54

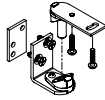
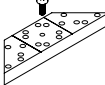
Part Number	Description	Cat. Page Ref.	View	Finish	Discount Quantity Pricing				
					1-5	6-10	11-24	25-99	100+
530024	T-Bolt Plunger Lock	RD17			35.00	33.60	32.90	32.20	30.80
550006-01	6" Shelf Blade Bracket (aluminum)	SC11 SH5 HA24		Non-Buffered Non-Brushed	14.99	14.39	14.09	13.79	13.19
550006-02	8" Shelf Blade Bracket (aluminum)	SC11 SH5 HA24		Non-Buffered Non-Brushed	15.75	15.12	14.81	14.49	13.86
550006-03	10" Shelf Blade Bracket (aluminum)	SC11 SH5 HA24		Non-Buffered Non-Brushed	16.61	15.95	15.61	15.28	14.62
550006-04	12" Shelf Blade Bracket (aluminum)	SC11 SH5 HA24		Non-Buffered Non-Brushed	17.22	16.53	16.19	15.84	15.15
550006-05	14" Shelf Blade Bracket (aluminum)	SC11 SH5 HA24		Non-Buffered Non-Brushed	17.86	17.15	16.79	16.43	15.72
550006-06	16" Shelf Blade Bracket (aluminum)	SC11 SH5 HA24		Non-Buffered Non-Brushed	18.61	17.87	17.49	17.12	16.38
550006-07	6" Shelf Blade Bracket (without lip - aluminum)	SC11 SH5 HA24		Non-Buffered Non-Brushed	14.99	14.39	14.09	13.79	13.19
550006-08	8" Shelf Blade Bracket (without lip - aluminum)	SC11 SH5 HA24		Non-Buffered Non-Brushed	15.75	15.12	14.81	14.49	13.86
550006-09	10" Shelf Blade Bracket (without lip - aluminum)	SC11 SH5 HA24		Non-Buffered Non-Brushed	16.61	15.95	15.61	15.28	14.62
550006-10	12" Shelf Blade Bracket (without lip - aluminum)	SC11 SH5 HA24		Non-Buffered Non-Brushed	17.22	16.53	16.19	15.84	15.15
550006-11	14" Shelf Blade Bracket. (without lip - aluminum)	SC11 SH5 HA24		Non-Buffered Non-Brushed	17.86	17.15	16.79	16.43	15.72
550006-12	16" Shelf Blade Bracket (without lip - aluminum)	SC11 SH5 HA24		Non-Buffered Non-Brushed	18.61	17.87	17.49	17.12	16.38
550007	Foot and Cap Assembly	SH6 SC16 HA24		Light Gray	1.25	1.20	1.18	1.15	1.10
550008	Chrome Bottom Cap Assembly for Steel Standard	HA26 SC16 SH7		Chrome	1.75	1.68	1.65	1.61	1.54

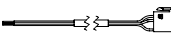
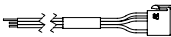
Part Number	Description	Cat. Page Ref.	View	Finish	Discount Quantity Pricing				
					1-5	6-10	11-24	25-99	100+
550009	Chrome Top Cap Assembly for Steel Standard	HA26 SC16 SH7		Chrome	2.25	2.16	2.12	2.07	1.98
550010-01	6" Tubular Shelf Bracket (aluminum)	SC11 HA25 SH6		Buffed or Brushed	19.00	18.24	17.86	17.48	16.72
550010-02	8" Tubular Shelf Bracket (aluminum)	SC11 HA25 SH6		Buffed or Brushed	19.00	18.24	17.86	17.48	16.72
550010-03	10" Tubular Shelf Bracket (aluminum)	SC11 HA25 SH6		Buffed or Brushed	19.50	18.72	18.33	17.94	17.16
550010-04	12" Tubular Shelf Bracket (aluminum)	SC11 HA25 SH6		Buffed or Brushed	20.00	19.20	18.80	18.40	17.60
550010-05	14" Tubular Shelf Bracket (aluminum)	SC11 HA25 SH6		Buffed or Brushed	20.50	19.68	19.27	18.86	18.04
550010-06	16" Tubular Shelf Bracket(aluminum)	SC11 HA25 SH6		Buffed or Brushed	21.00	20.16	19.74	19.32	18.48
550011	Shelf End Clip for 550010	SC16 HA25 SH6		Zinc	4.15	3.98	3.90	3.82	3.65
550012	Shelf Center Clip for 550010	SC16 HA25 SH6		Zinc	1.48	1.42	1.39	1.36	1.30
550013	Glass End Clip for 550006	SC16 HA26 SH5		Zinc	2.60	2.50	2.44	2.39	2.29
550014	Glass Center Clip for 550006	SC16 HA26 SH5		Zinc	2.60	2.50	2.44	2.39	2.29
570003	Leveler Assembly	FM4 HA21			2.19	2.10	2.06	2.01	1.93
570004	Angle Bracket	FM4 HA21		Non-Buffed Non-Brushed	5.10	4.90	4.79	4.69	4.49
570005	Panel Clip (includes hardware and 4 clips)	FM4			5.98	5.74	5.62	5.50	5.26

Part Number	Description	Cat. Page Ref.	View	Finish	Discount Quantity Pricing				
					1-5	6-10	11-24	25-99	100+
570013	Pivot Hinge Assembly	FM4 HA21			12.74	12.23	11.98	11.72	11.21
570546	Drill Block Tool Accessory	FM4			41.40	39.74	38.92	38.09	36.43
580747-01	Wiring Harness Assy, 2-22A WG Wire w/2 Female Receptacles 156"	SC34			7.01	6.73	6.59	6.45	6.17
580817-01	Wiring Harness Cable 3 18A WG 156"	SC34			15.24	14.63	14.33	14.02	13.41
580818-01	Wiring Harness, 3 18A WG 156"	SC34			15.28	14.67	14.36	14.06	13.45
580824-01	Wiring Harness, 2 18AWG Power Track LVS				18.64	17.89	17.52	17.15	16.40
590866	Wall Mounting Kit, includes wall anchors and screws				0.42	0.40	0.39	0.39	0.37

# Stock Length Rolling Door Kits

Part Number	Description	Includes:				Cat. Page Ref.	Non-Buffered, Non-Brushed Finish			Buffered or Brushed Finish		
		Wheels	Retainers	Jamb	Verticals		Qty 1	Qty 6	Qty 11	Qty 1	Qty 6	Qty 11
610005-02	Standard Rolling Door Assembly with Removable Track, 12 ft.	8	No	No	n/a	RD5	89.11	85.49	83.72	105.11	100.85	98.76
610007-02	Economy Rolling Door Assembly, 12 Ft.	8	No	No	n/a	RD5	63.92	61.31	60.04	75.39	72.32	70.83
610060-02	Wood Rolling Door Assembly, 12 ft.	8	No	n/a	n/a	RD6	46.62	44.73	43.78	51.74	49.64	48.60
610099-02	Standard Rolling Door Assembly, 12 ft.	8	No	n/a	n/a	RD5	72.57	69.61	68.17	89.64	86.00	84.22
610143-02	Security Rolling Door Assembly, 12 ft. - 110008 Header, 110012 Shoe	8	8	Yes	Yes	RD7	182.16	175.07	171.65	223.33	214.60	210.35
610144-02	Security Rolling Door Assembly, 12 ft. - 110071 Header, 110012 Shoe	8	8	Yes	Yes	RD7	219.06	210.51	206.35	261.98	251.71	246.70
610145-02	Security Rolling Door Assembly, 12 ft. - 110102 Header, 110012 Shoe	8	8	Yes	Yes	RD7	225.70	216.88	212.59	266.29	255.85	250.75
610146-02	Security Wood Rolling Door Assembly, 12 ft. - 110162 Top Channel, 110208 Security Track	8	8	n/a	n/a	RD6	91.98	88.27	86.45	106.62	102.32	100.21
610165-02	Triple Track Rolling Door Assembly, 12 ft.	6	n/a	n/a	n/a	RD8	146.76	140.80	137.98	172.26	165.28	161.95
610183-02	Security Rolling Door Assembly, 12 ft. - 110102 Header, 110412 Shoe	8	8	Yes	n/a	RD9	229.21	221.31	217.51	264.29	254.98	250.49
610184-02	Security Rolling Door Assembly, 12 ft. - 110071 Header, 110412 Shoe	8	8	Yes	n/a	RD9	220.89	213.25	209.59	258.30	249.16	244.76
610185-02	Security Rolling Door Assembly, 12 ft. - 110008 Header, 110412 Shoe	8	8	Yes	n/a	RD9	183.99	177.81	174.89	219.65	212.05	208.41
610187-02	Heavy Duty Security Rolling Door Assembly, 12 ft. - 110008 Header, 110140 Shoe	8	8	Yes	Yes	RD10	242.84	235.36	231.77	283.05	273.96	269.57
610188-02	Heavy Duty Security Rolling Door Assembly, 12 ft. - 110071 Header, 110140 Shoe	8	8	Yes	Yes	RD10	279.74	270.79	266.48	321.70	311.07	305.92
610189-02	Heavy Duty Security Rolling Door Assembly, 12 ft. - 110102 Header, 110140 Shoe	8	8	Yes	Yes	RD10	286.38	277.17	272.72	326.01	315.21	309.97
610190-02	Security Rolling Door Assembly, 12 ft. - 110008 Header, 110350 Shoe	8	8	Yes	Yes	RD11	250.59	242.50	238.61	294.54	284.69	279.93
610191-02	Security Rolling Door Assembly, 12 ft. - 110071 Header, 110350 Shoe	8	8	Yes	Yes	RD11	241.87	234.14	230.44	277.85	268.68	264.26
610192-02	Security Rolling Door Assembly, 12 ft. - 110102 Header, 110350 Shoe	8	8	Yes	Yes	RD11	294.13	284.31	279.56	337.50	325.94	320.33

**Note:** Lock and vinyl are sold separately when 12' assemblies are ordered.

# Admire LED Mirror

The ADMIRE LED Mirror from Stylmark combines budget-friendly design with flattering soft white LED lighting to a full length mirror perfect for fitting rooms.

Mirror Solutions by Stylmark

## Admire LED Mirror

The simple styling will fit almost any decor. With the compact depth of the ADMIRE LED Mirror, fitting into your smaller rooms won't be a concern. Complement the fitting room experience and ease the buying decision with Stylmark's ADMIRE LED Mirror.

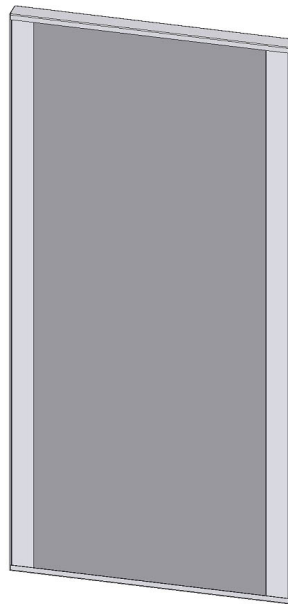

Admire LED Mirror  
Model 620105-01-OBWHT40111

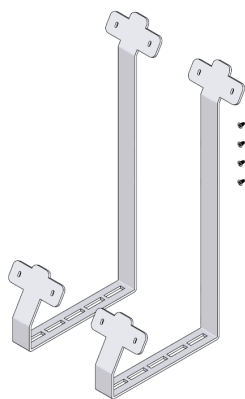

Part # 520079- OBWHT40111  
60° Wing Bracket

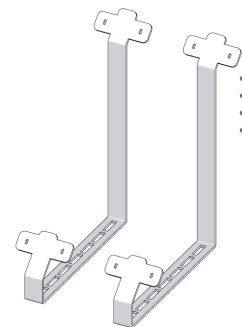

Part # 520078-OBWHT40111  
45° Wing Bracket

# Admire LED Mirror

Contact your Stylmark representative for Admire mirror pricing.

Model	Description <i>Note: White powder coat finish # OBWHT40111</i>	Mirror Size (glass dimension)
620105-01-OBWHT40111	Admire LED Mirror - White (Hardwired)	28" x 60"
620105-02-OBWHT40111	Admire LED Mirror - White (Hardwired, On/Off Switch)	28" x 60"
620105-03-OBWHT40111	Admire LED Mirror - White (Plug-in Cord)	28" x 60"
620105-04-OBWHT40111	Admire LED Mirror - White (Plug-in Cord, On/Off Switch)	28" x 60"
620105-05-OBWHT40111	Admire LED Mirror - White (Low Light, On/Off Switch)	28" x 60"
620105-06-OBWHT40111	Admire LED Mirror - White (Low Light, Plug-in Cord, On/Off Switch)	28" x 60"
620105-07-OBWHT40111	Admire LED Mirror - White (Plug-in Cord, On/Off Switch)	28" x 72"
620106-01 OBWHT40111	Admire Mirror Wing	14" x 60"
620106-02 OBWHT40111	Admire Mirror Wing	14" x 72"
520078-OBWHT40111	45° Wing Bracket Kit (one kit required per wing, contains two brackets)	N/A
520079-OBWHT40111	60° Wing Bracket Kit (one kit required per wing, contains two brackets)	N/A
520075	Cleat Mounting Accessory Kit	N/A
227025	Glass Installation Suction Cup, 4-1/2" dia, 80 lb capacity	N/A

Admire LED Mirror Product Information	
Data Sheet	971827
Installation Instructions	971826

# Cafe Barrier System

The Café Barrier System from Stylmark consists of a variety of components used to create partition systems. The Clamp system uses brackets to secure the 1/4" panel to the post and provides a clean, modern aesthetic. A more traditional look is achieved with the Channel system that uses recessed channels and plastic glazing to secure the panel. Post are sold in stock lengths (12') and in prefabricated 24" and 36" lengths for selected finishes. Optional accessories are available.

Cafe Barrier System by Stylmark

## Panel Channel System

Prefabricated posts available in 24" or 36" lengths  
Standard finishes: Satin Natural (020) or Satin Brass (021)

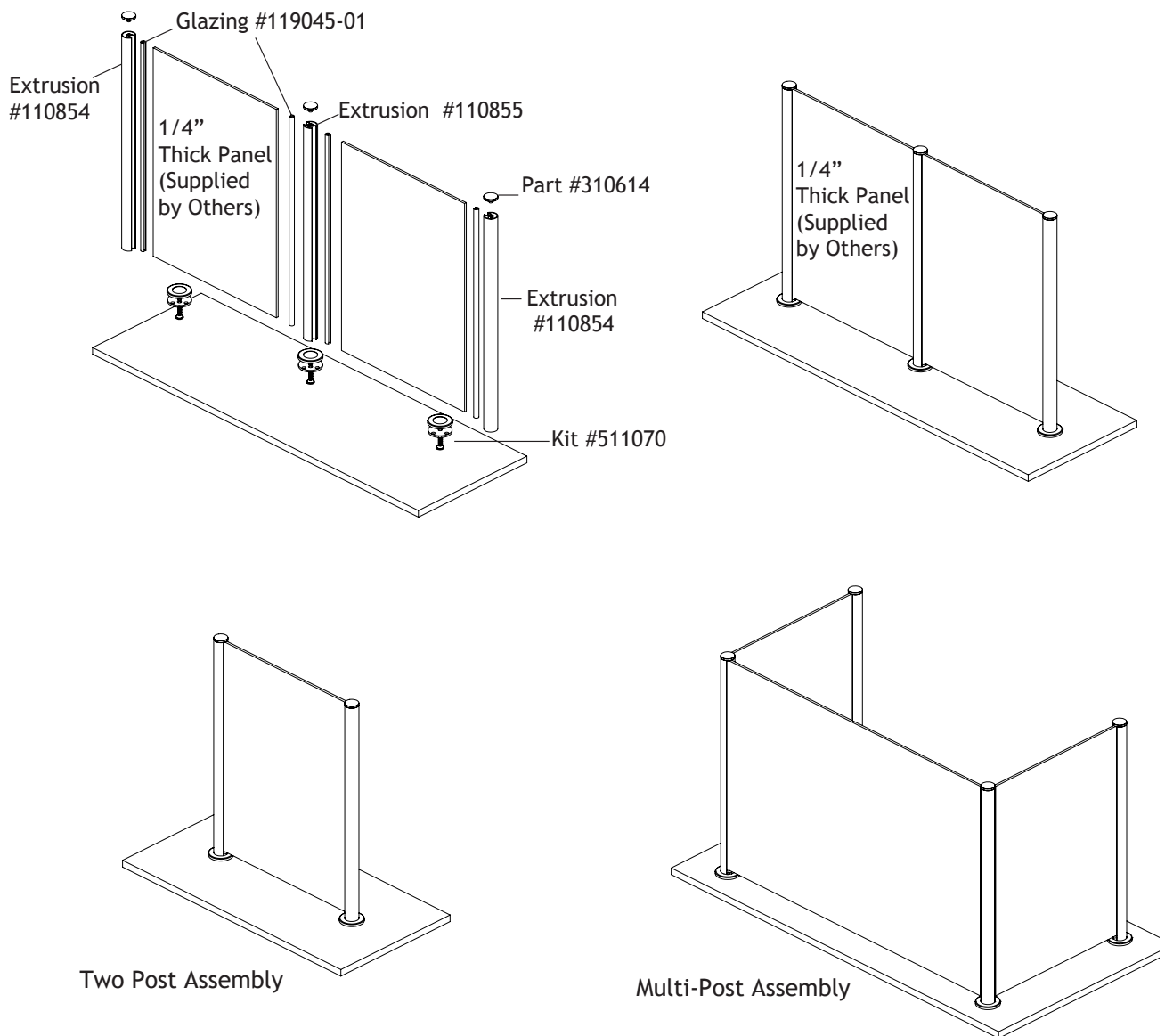



# Cafe Barrier System

## Panel Clamp System

Prefabricated posts available in 24" or 36" lengths  
Standard finishes: Satin Natural (020) or Satin Brass (021)

Cafe Barrier System by Stylmark

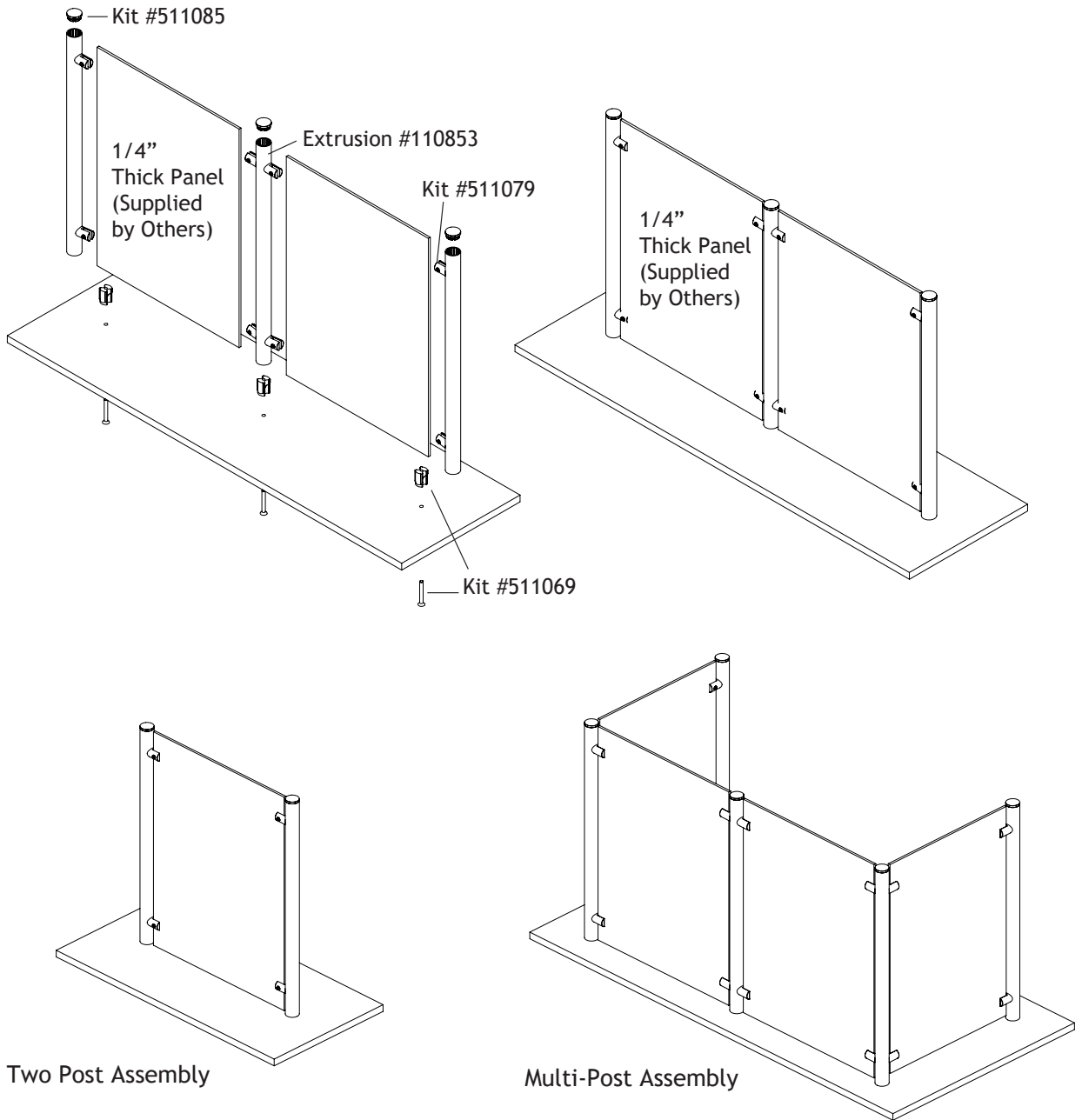

Two Post Assembly

Multi-Post Assembly

# Cafe Barrier System Stocked Component Pricing

If alternative sizes are needed or if you want to fabricate your own barrier, Stylmark offers stocked length extrusion and hardware to order.

Part Number	Description	Discount Quantity Pricing				
		1-5 Units	6-10 Units	11-24 Units	25-99 Units	100+ Units
491007-01-020	Smooth Post, 24" Length, 020 Finish (Extrusion 110853)	10.60	10.18	9.96	9.75	9.33
491007-01-021	Smooth Post, 24" Length, 021 Finish (Extrusion 110853)	10.60	10.18	9.96	9.75	9.33
491007-02-020	Smooth Post, 36" Length, 020 Finish (Extrusion 110853)	13.78	13.23	12.95	12.68	12.13
491007-02-021	Smooth Post, 36" Length, 021 Finish (Extrusion 110853)	13.78	13.23	12.95	12.68	12.13
491008-01-020	Single Channel Post, 24" Length, 020 Finish (Extrusion 110854)	15.64	15.01	14.70	14.39	13.76
491008-01-021	Single Channel Post, 24" Length, 021 Finish (Extrusion 110854)	15.64	15.01	14.70	14.39	13.76
491008-02-020	Single Channel Post, 36" Length, 020 Finish (Extrusion 110854)	18.82	18.07	17.69	17.31	16.56
491008-02-021	Single Channel Post, 36" Length, 021 Finish (Extrusion 110854)	18.82	18.07	17.69	17.31	16.56
491009-01-020	Double Channel Post, 24" Length, 020 Finish (Extrusion 110855)	16.27	15.62	15.29	14.97	14.32
491009-01-021	Double Channel Post, 24" Length, 021 Finish (Extrusion 110855)	16.27	15.62	15.29	14.97	14.32
491009-02-020	Double Channel Post, 36" Length, 020 Finish (Extrusion 110855)	19.77	18.98	18.58	18.19	17.40
491009-02-021	Double Channel Post, 36" Length, 021 Finish (Extrusion 110855)	19.77	18.98	18.58	18.19	17.40
119045	Glazing, 96" Length (use with channel post)	47.55	47.55	47.55	47.55	47.55
392706-01	Glazing, 24" Length (use with channel post)	12.80	12.29	12.03	11.78	11.26
392706-02	Glazing, 36" Length (use with channel post)	19.20	18.43	18.05	17.66	16.90
310614-020	Endcap, Round Threaded, 020 Finish	7.20	6.91	6.77	6.62	6.34
310614-021	Endcap, Round Threaded, 021 Finish	7.20	6.91	6.77	6.62	6.34
511085-020	Kit, End Cap w/Insert 020 Finish	11.50	11.04	10.81	10.58	10.12
511085-021	Kit, End Cap w/Insert 021 Finish	11.50	11.04	10.81	10.58	10.12
511079-020	Kit, 1.0 Dia Vertical Panel Clamp, 020 Finish	25.95	24.91	24.39	23.87	22.84
511079-021	Kit, 1.0 Dia Vertical Panel Clamp, 021 Finish	25.95	24.91	24.39	23.87	22.84
511069	Kit, Supporting Fixing 90 Deg Mtng Flange	26.00	24.96	24.44	23.92	22.88
511070-020	Kit, Mounting Base, 020 Finish	13.85	13.30	13.02	12.74	12.19
511070-021	Kit, Mounting Base, 021 Finish	13.85	13.30	13.02	12.74	12.19
511216-020	Accessory Kit, Table Top Clamp, 020 Finish	30.08	28.88	28.28	27.67	26.47
511216-021	Accessory Kit, Table Top Clamp, 021 Finish	30.08	28.88	28.28	27.67	26.47
110853	Smooth Post (used with panel clamps)	60.90	58.46	57.25	56.03	53.59
110854	Post, Single Channel	72.41	69.51	68.07	66.62	63.72
110855	Post, Double Channel	78.86	75.71	74.13	72.55	69.40



Stylmark, Inc.  
6536 Main Street NE, PO Box 32008  
Minneapolis, MN 55432

Phone: 800-328-2495 763-574-7474 Fax: 763-574-1415  
stylmark.com info@stylmark.com