

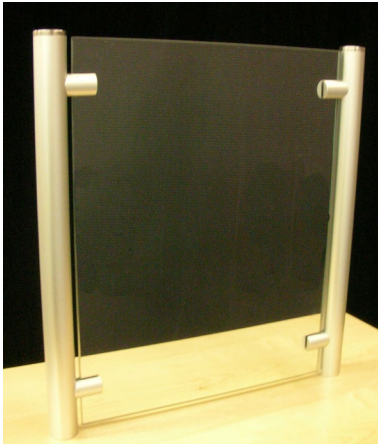

Data Sheet

Café Series Partition Hardware

Café Series – Glass Clamp



General Description: The Café Series from Stylmark consists of a variety of components used to create Partition Systems. The Glass Clamp system uses brackets to secure the glass to the post and provides a clean, modern aesthetic. A more traditional look is achieved with the Glass Channel system that uses recessed channels and plastic glazing to secure the glass. Posts are sold in 12' stock lengths for size customization. Optional accessories include end caps, shelf brackets and base attachment hardware.

Applications: Sneeze guards, booth partitions, salad bar/cafeteria posts and glass shields

Material: Anodized aluminum

Anodized Finish: See Stylmark color library

Post Options:

- Glass channel with single or double groove
- Glass clamp style

Note: Posts are sold in 12' stock lengths

Panels: 1/4" tempered glass (supplied by others)
6 mm tempered glass (supplied by others)

End caps: Screw in end cap for both systems

Mounting: Base and post mounting available

Multi Pane Option: Available in both systems

Café Series – Glass Channel

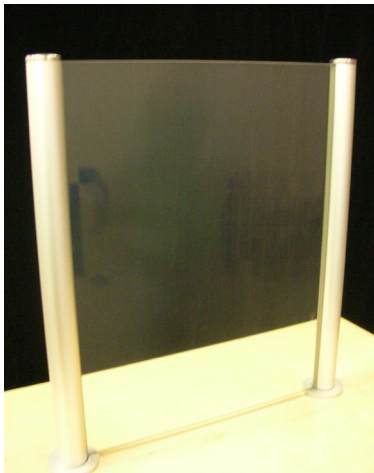

Post Options

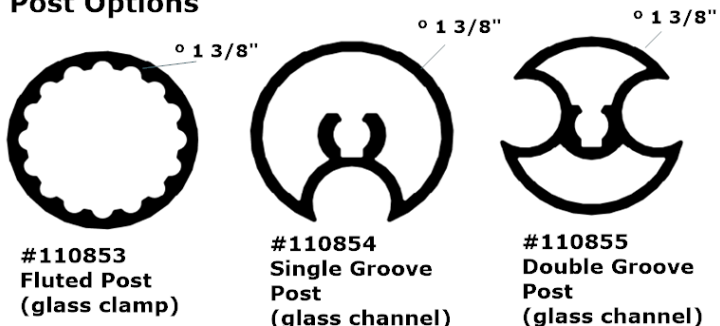

In order to continually improve our products, Stylmark reserves the right to make changes to specifications or materials without prior notice.

Sheet# 971595
Revision C (6/20)

Layout Options

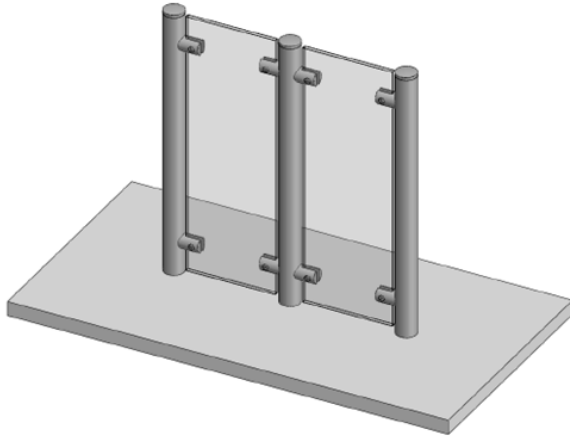

**Café Series
Glass Clamp
Multi Panes System**

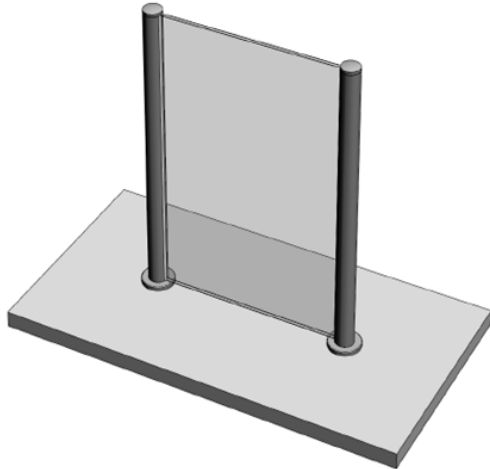

**Café Series
Glass Channel
Single Pane System**

Café Series Accessories

Glass Channel Accessories

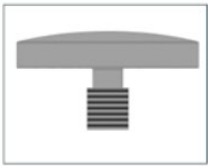

**#310614
Endcap**



**#511070
Channel
Mounting Kit**



**#119045 -01
Glazing**

Glass Clamp Accessories



**#511069
Clamp
Mounting Kit**

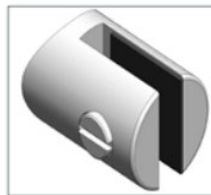

**#511079
Fixed Vertical
Bracket Kit**

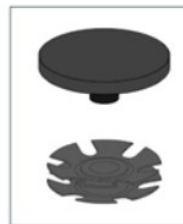

**#511085
Endcap with
Insert**