

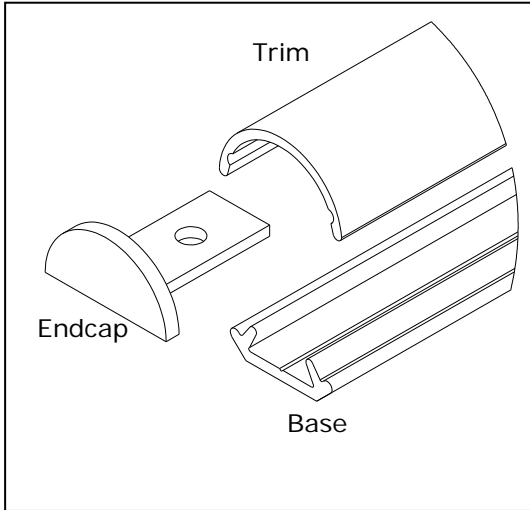

Data Sheet

Trim Maker[®]

Architectural Trim and Molding



General Description: Trim Maker from Stylmark is an easy way to add architectural accents to walls, ceilings, soffits and columns. To install simply secure the base and snap the trim into place. Trim and base stock lengths may be field cut or fabricated to order at Stylmark. Endcaps to finish exposed edges are available on most profiles. Trim Maker may be curved to meet specific radius requirements.

Applications: Crown molding, chair rail, columns, frieze, door surrounds

Material: Anodized aluminum

Anodized Finish: See Stylmark Color Library

Profiles: Quarter Rounds, Half Rounds, Rectangular, Special Shapes & Custom Profiles

Endcaps: Friction fit tabs into the base or mechanically fasten tab to the base

FTOE01
CTOE01
CURV01

In order to continually improve our products, Stylmark reserves the right to make changes to specifications or materials without prior notice.

Installation Instructions



Step One: Ensure the mounting surface is flat and level. Mount the necessary length of base in the desired location by driving fasteners through pre-punched mounting holes.



Step Two: Align the Trim Maker extrusion to the catch rails of the base and press it into the base.

Sheet# 971531
Revision C (8/10)

Quarter Rounds

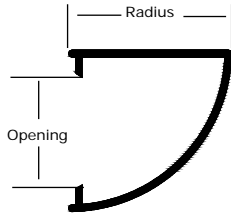

Trim Part #	Radius	Opening	Base Part #	Endcap RH Part #	Endcap LH Part #
110286	3"	2"	410540	310239	310242
110290	1 1/2"	1"	410443	310240	310243
110296	3/4"	5/8"	411331	310375	310374
110299	1 1/4"	11/16"	410530	310244	310245
110308	2"	1"	410443	310252	310253
110309	2 1/2"	2"	410540	310254	310255

Half Rounds

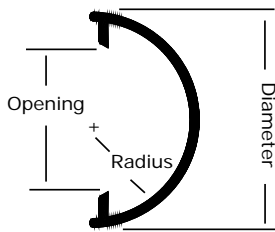

Trim Part #	Radius	Diameter	Opening	Base Part #	Endcap Part #
110200	3/4"	1 1/2"	1"	410443	310204
111201	1"	2"	1"	410443	310205
110202	1 1/2"	3"	2"	410540	310206
110210	2"	4"	3"	410458	310207
110211	2 1/2"	5"	4 1/2"	412002	310208
110212	3"	6"	4 1/2"	412002	310209
110267	3/8"	3/4"	5/8"	411331	310395
110285	2 1/4"	4 1/2"	3"	410458	310238
110295	1"	2"	1"	410443	310205
110310	1 1/4"	2 1/2"	2"	410540	310249
110328	1/2"	1"	5/8"	411331	310323

Rectangulars

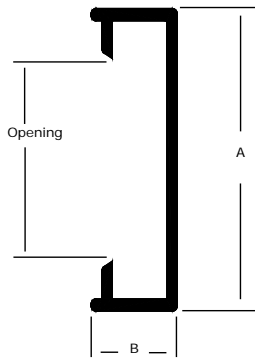

Trim Part #	A	B	Opening	Base Part #	Endcap Part #
110223	1 3/8"	21/64"	1"	410443	310212
110225	1 1/2"	1/2"	1"	410443	310213
110226	3"	3/4"	2"	410540	310214
110227	4"	3/4"	3"	410458	310215
110232	4"	2"	3"	410458	310218
110245	3"	1 1/2"	2"	410540	310229
110248	1"	1/2"	5/8"	411331	-
110269	6"	3/4"	4 1/2"	412002	310235
110294	1 1/2"	1/2"	1"	410443	310241
110304	2 1/4"	1/2"	1"	410443	310251
110307	2"	5/8"	1"	410443	310250
110410	3/4"	3/4"	5/8"	411331	310403
110639	2"	1"	1"	410443	-
110672	3/4"	3/16"	21/32"	412007	-

Special Shapes: For a full selection of our Special Shapes, visit our website at www.stylmark.com

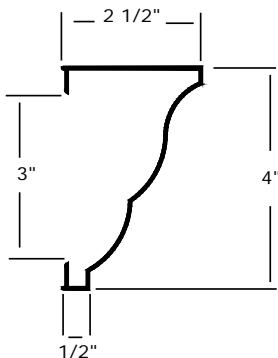

110214

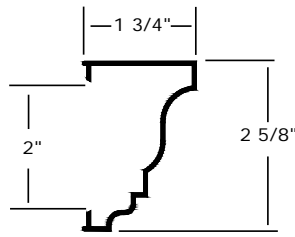

110382

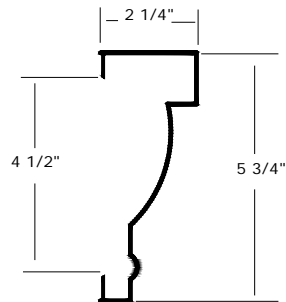

110465

Sheet# 971531
Revision C (8/10)