



Showcases

Showcase systems offer a wide selection of framing, lighting and door options that allow you to integrate the components of your choice into a custom showcase that meets your exact specifications. Experience in showcases has enabled us to perfect the alignment of each component into curved, clipped or straight configurations.

| | |
|------------------------------|----|
| Curving Capabilities | 2 |
| Showcase Configurations | 3 |
| Aluminum Glass End Showcases | 4 |
| Aluminum Wood End Showcases | 12 |
| Light Reflectors | 17 |
| Lighting Accessories | 29 |

Curving

Bring it all together with a few carefully placed curves. Stylmark is able to curve virtually all of our products to meet your radius requirements. Simply provide us with dimensions as indicated below and watch your design come to life!

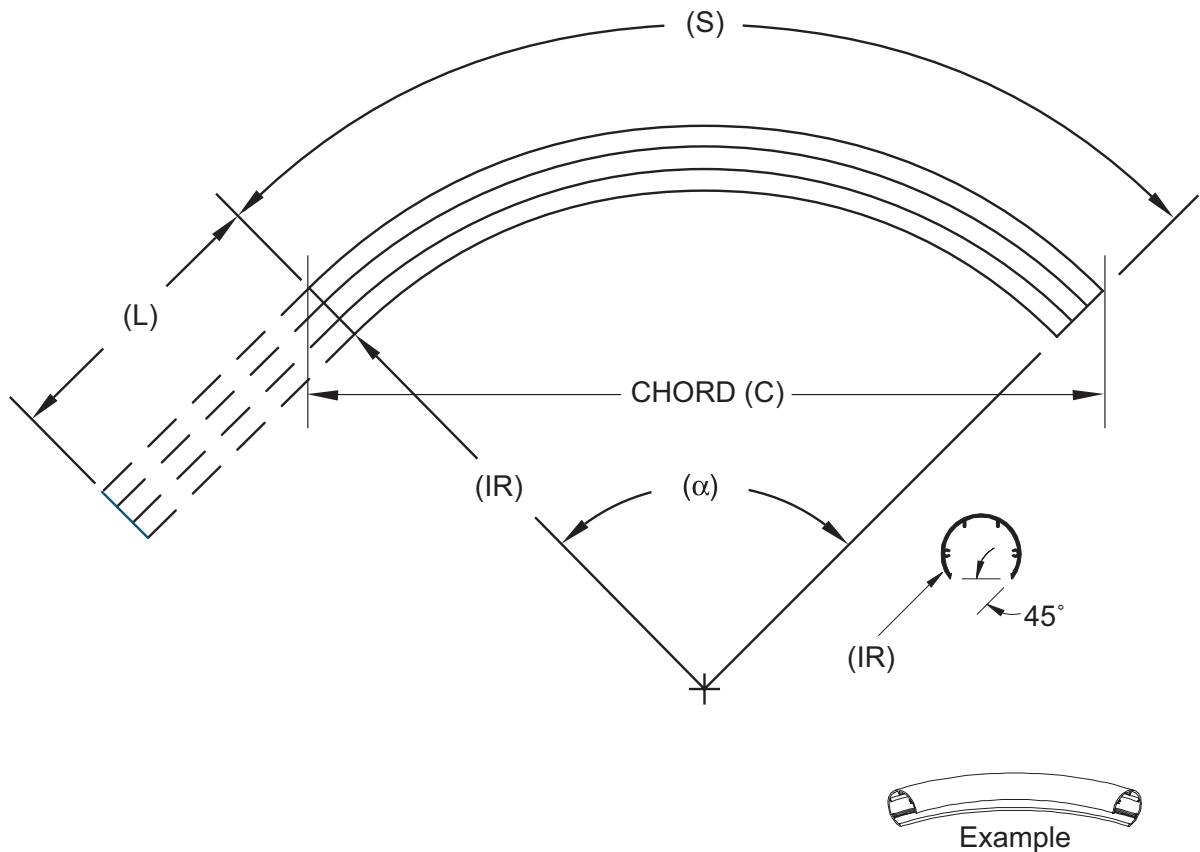

Required Information:

- Orientation of part to be curved
- Radius (IR)
- Arc Length (S)
- Chord (c) or Included Angle (α)
- Straight Length (L)

Notes:

- Provide AutoCAD® or SolidWorks drawing if available

Showcase Configurations

Stylmark's showcases are available in a variety of view and shape configurations. In addition to those shown below, Stylmark provides vertical cases up to 48" tall as well as octagonal, L-shaped and curved corner showcases. We can accommodate most heights and widths and our in-house engineering staff is always available to customize a case to fit your needs.

View Variations

Full Vision

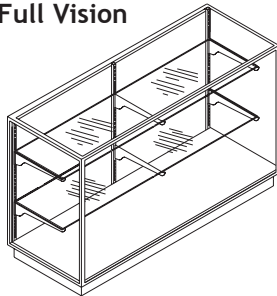

Half Vision

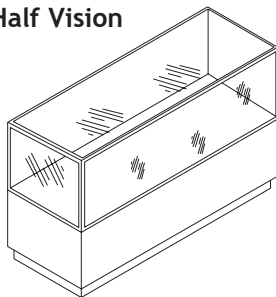

One-Third Vision

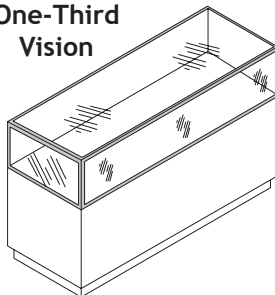

Shape Variations

- Top View -

Rectangular/Square

Customer Side

Double Clip

Customer Side

Left Hand Clip

Customer Side

Right Hand Clip

Customer Side

Curved

Customer Side

Aluminum Glass End Showcases

Creating sleek, contemporary displays is easy with Stylmark's glass end showcase products. Available in a variety of configurations and anodized finishes, our cases are secure due to top glass security channels and spot welded corner brackets. Glass end showcases are sold as knock-down, fabricated assemblies including frames, doors and reflectors.

Standard Showcase Assembly

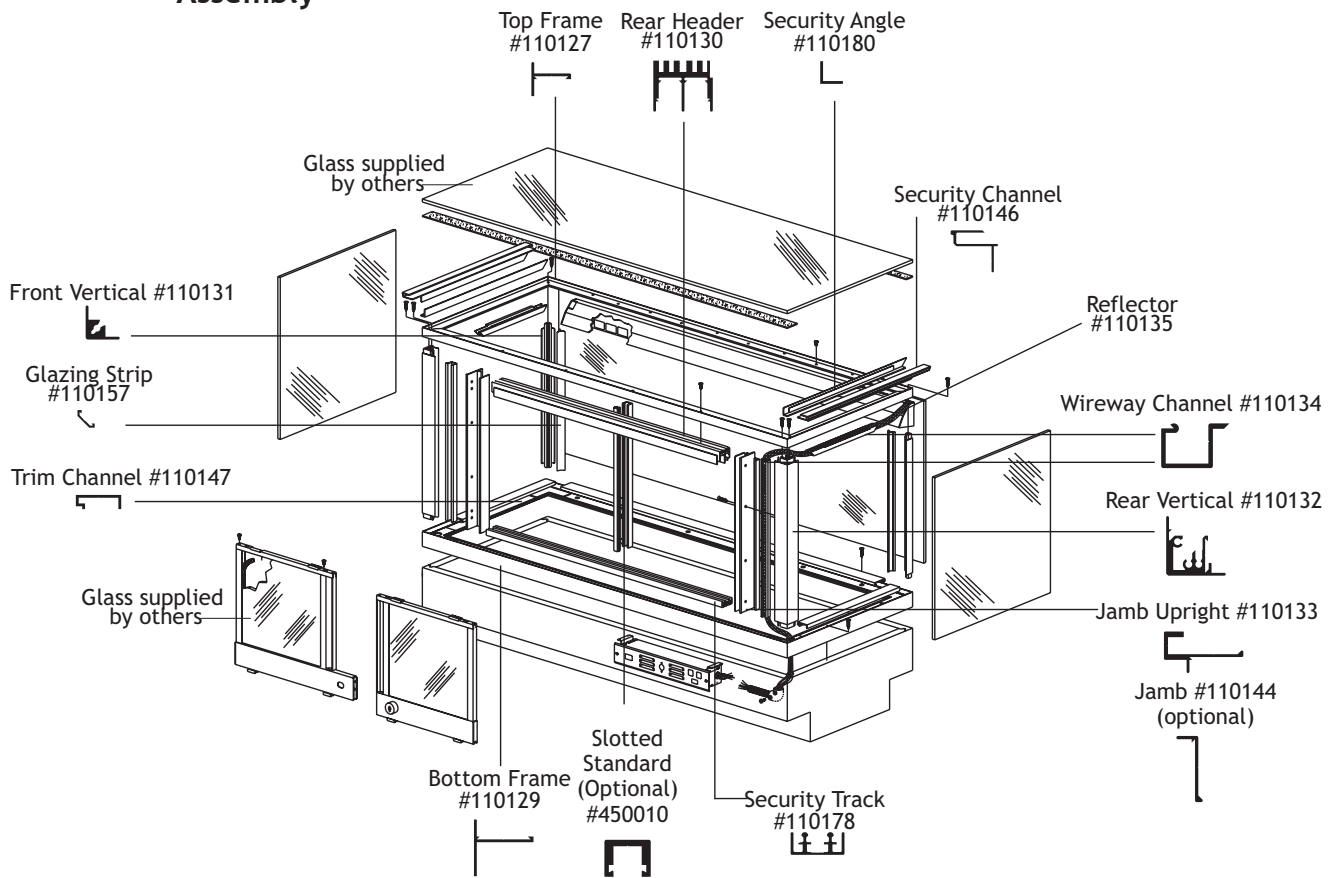

Aluminum Glass End Showcases

Showcase Components Typical Horizontal Section

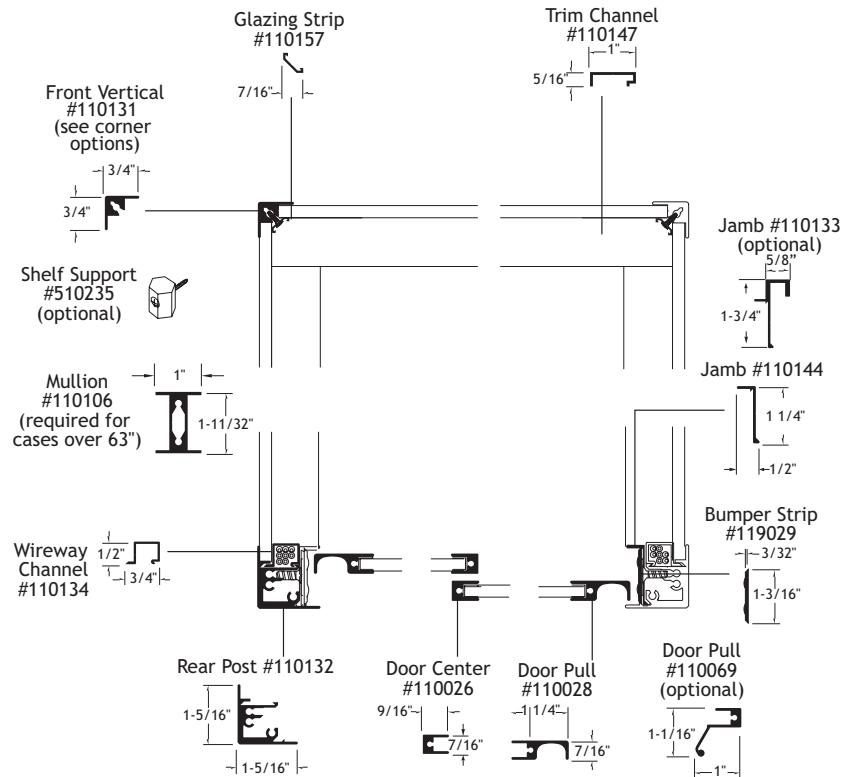

Showcase Components Typical Vertical Section

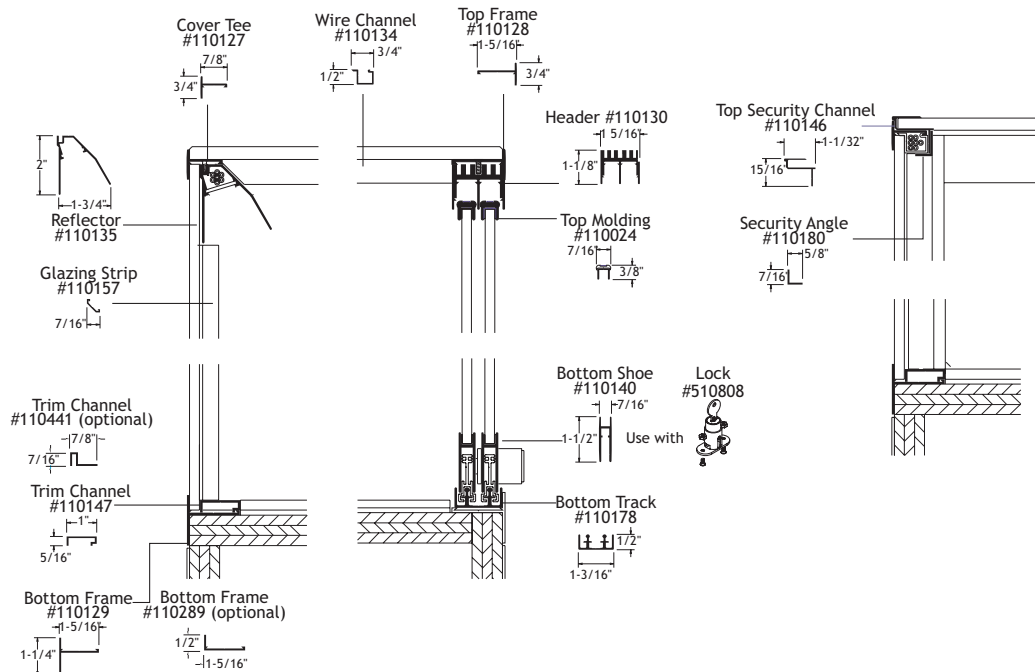

Notes: • Aluminum glass end showcase components are not sold individually.

Aluminum Glass End Showcases

Rectangular Showcases

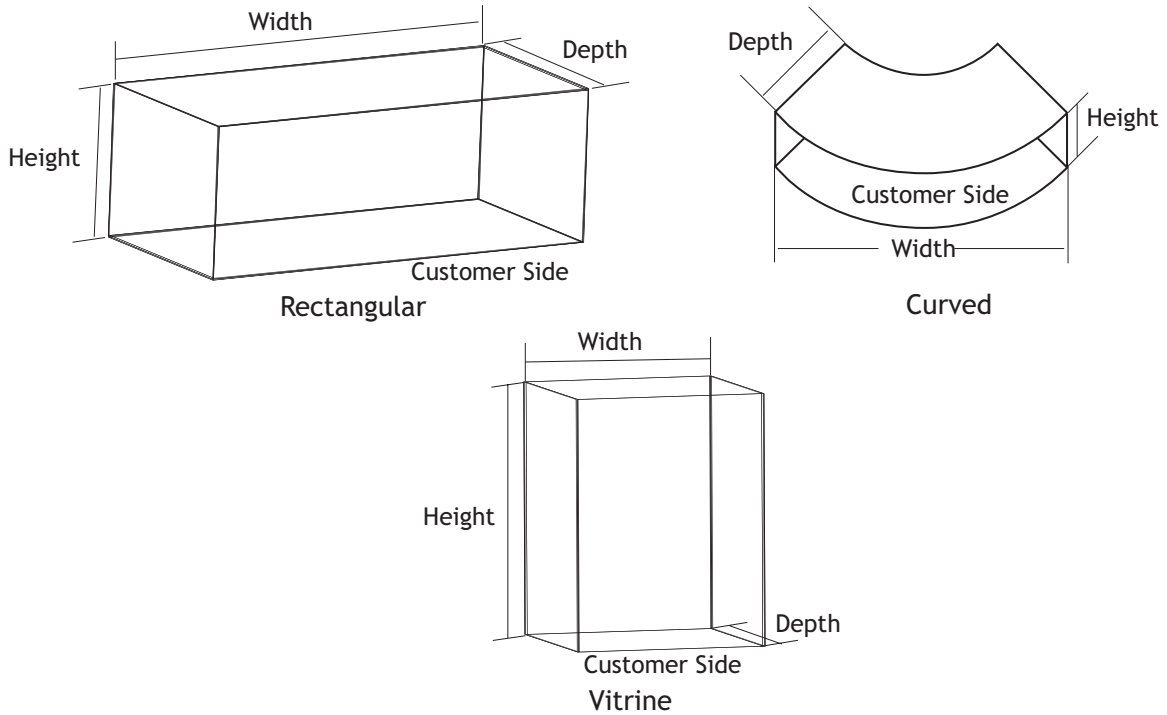

Rectangular Showcases

| Model # | Reflector Location | Door Type | Bottom Profile (Standard or Low) | Jamb (Regular or Slotted) | Mullion (With or Without) |
|---------|--------------------|-------------------|----------------------------------|---------------------------|---------------------------|
| 710111 | Front Only | Rolling Door | Standard or Low | Regular or Slotted | With or Without |
| 710112 | Front and Rear | Rolling Door | Standard or Low | Regular or Slotted | With or Without |
| 710113 | Rear Only | Rolling Door | Standard or Low | Regular or Slotted | With or Without |
| 710114 | No Reflector | Rolling Door | Standard or Low | Regular or Slotted | With or Without |
| 710115 | Front Only | Wood Hinged Door | Standard or Low | Regular Only | With Mullion |
| 710314 | No Reflector | Glass Hinged Door | Standard or Low | N/A | Without Mullion |

For lighting options, please refer to the showcase lighting section of this catalog

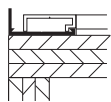

Bottom Profile Low

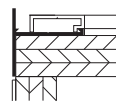

Bottom Profile Standard

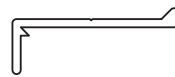

Jamb Regular



Jamb Slotted



Mullion

- Notes:**
- When ordering clipped, curved or custom showcases, please provide shop drawings.
 - Aluminum glass end showcase components are not sold individually.
 - Indicate bottom trim channel for inside of case.

Aluminum Glass End Showcases

Single Clipped and Double Clipped Showcases

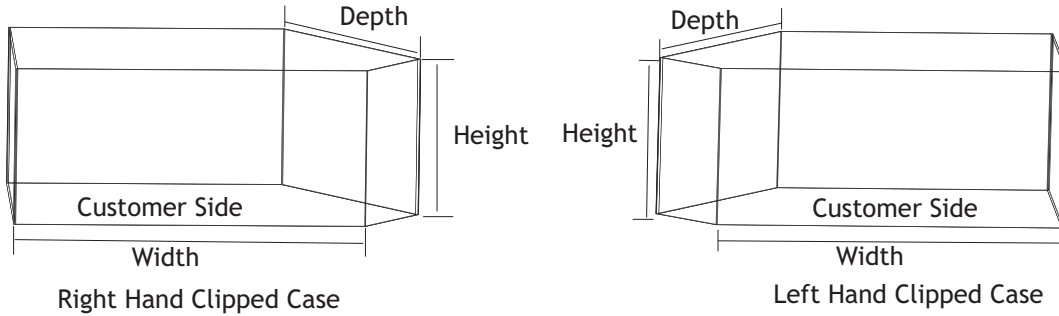

Right or Left Hand Clipped

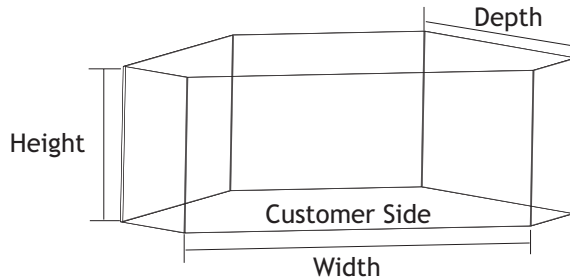

Double Clipped

Single and Double Clipped Showcases

| Model # | Description | Reflector Location | Door Type | Bottom Profile Standard | Jamb (Regular or Slotted) | Mullion (With or Without) |
|---------|----------------|--------------------|------------------|-------------------------|---------------------------|---------------------------|
| 710121 | Single Clipped | Front | Rolling Door | Standard | Regular or Slotted | Without Mullion |
| 710131 | Double Clipped | Front | Rolling Door | Standard | Regular or Slotted | With or Without |
| 710135 | Double Clipped | Front | Wood Hinged Door | Standard | Regular Only | Without Mullion |

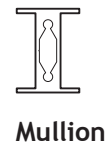
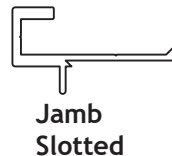
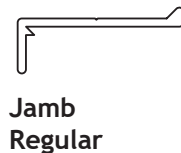

- Notes:**
- When ordering clipped, curved or custom showcases, please provide shop drawings.
 - Aluminum glass end showcase components are not sold individually.
 - Indicate bottom trim channel for inside of case.

Aluminum Glass End Showcases

Showcase Options

Top Frame Options

Choose from the options shown below or combine a front and rear reflector in one showcase.

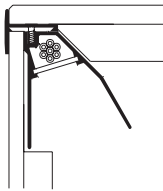

Top frame with front reflector and front glass

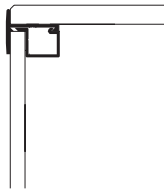

Top frame with no front reflector and front glass

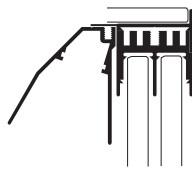

Rear header with rear reflector

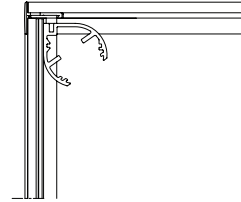

Top frame with teardrop reflector and front glass

Door Options

Fully framed security rolling doors are standard. Optional hinged doors can be ordered top, bottom or side hinged. Glass hinged door showcases typically have an extruded hinge. Piano hinge is an option. Glass and wood door panels are supplied by others.

Top or bottom hinged doors will allow for full width access to a 1/3 view case. Hinged doors with 1/4" thick panels, will accept Kenstan locks.

Wood Hinged Door - Top



Glass Hinged Door - Top

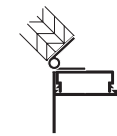

Wood Hinged Door - Bottom

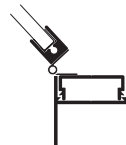

Glass Hinged Door - Bottom



Glass Hinged Door - side

Front Corner Options

Front vertical #110131 is standard on all rectangular showcases and is used on clipped cases. Vertical #110142 is used only on clipped cases.

Front Vertical #110131

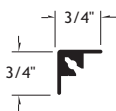

Glazing Strip #110157

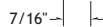

Shelf Support #510235 (optional)

Front Vertical #110142 135 degree



Glazing Strip #110157

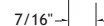

Aluminum Glass End Showcases

Showcase Options

Bottom Frame Options

Choose from the options shown below for your showcase's bottom frame. Trim Channel #110147 can be used with either bottom frame profile. The Trim Channel covers the bottom frame and assists in installation of a pad.

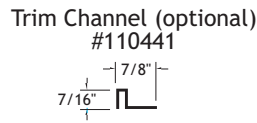
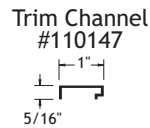
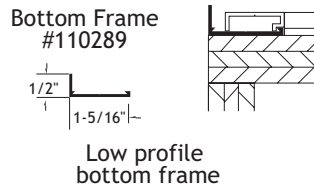
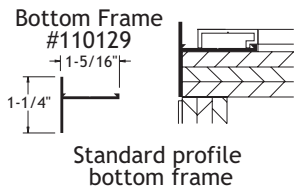

Shoe and Lock Options

For standard aluminum glass end showcases with rolling doors you have the option of the shoe and lock combinations listed below.

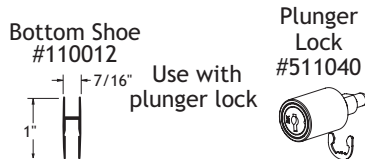
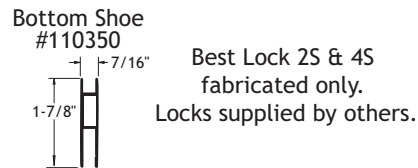
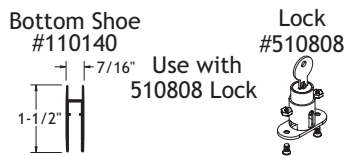

Aluminum Glass End Showcases

Showcase Options

Rear Corner Options

Rear posts serve as a clear wireway downtube, door jamb and slotted standard for brackets. Full height door bumpers are included. Mullions are required on cases over 63" and serve as dividers for hinged doors.

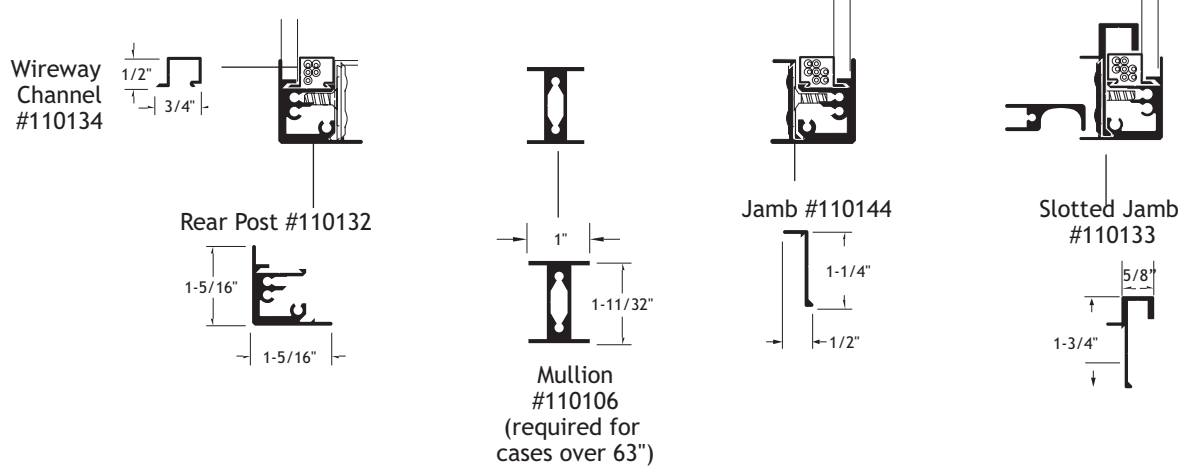

Hardware and Accessories

Part #550011
Shelf End Clip
for 550010

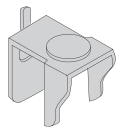

Part #550012
Shelf Center
Clip for 550010

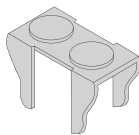

Part #550013
Glass End Clip
for 550006

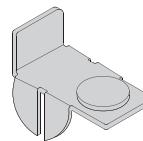

Part #550014
Glass Center Clip
for 550006

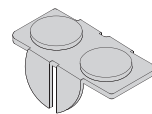

Part #450010
Slotted Standard

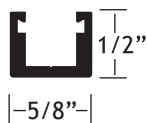

Part #450022
Rear Support
for #450010



Part #510235
Shelf Support

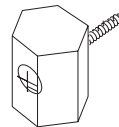

Part #110224
Glazing, Jamb w/o Leg

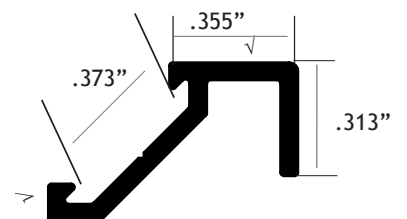

Aluminum Glass End Showcases

Hardware and Accessories

Part # 550006: Shelf Bracket

This aluminum shelf bracket is typically used with 1/4" glass shelving. It is available in 6", 8", 10", 12", 14", and 16" depths, with or without a lip. (Non-buffed or non-brush finishes only)

#550006 Shelf Bracket With Lip

| | |
|------------------|-----|
| Part # 550006-01 | 6" |
| Part # 550006-02 | 8" |
| Part # 550006-03 | 10" |
| Part # 550006-04 | 12" |
| Part # 550006-05 | 14" |
| Part # 550006-06 | 16" |

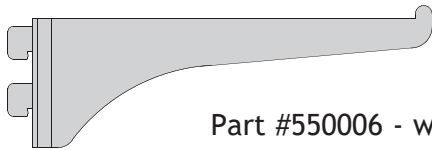

Part #550006 - with lip

#550006 Shelf Bracket Without Lip

| | |
|------------------|-----|
| Part # 550006-07 | 6" |
| Part # 550006-08 | 8" |
| Part # 550006-09 | 10" |
| Part # 550006-10 | 12" |
| Part # 550006-11 | 14" |
| Part # 550006-12 | 16" |

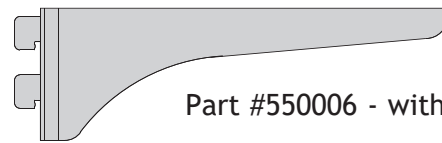

Part #550006 - without lip

Part # 550010

Heavy Duty Tubular Bracket

Our heavy duty tubular bracket adds a contemporary look with the ability of supporting 3/8" to 1/2" thick glass shelves with ease. It is available in 6", 8", 10", 12", 14", and 16" depths. (Buffed or brushed finishes only)

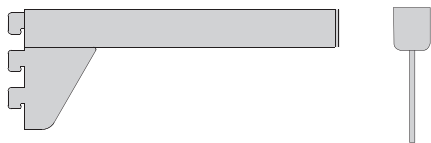

Heavy Duty Tubular Brackets

#550010 brackets are available in six sizes:

| | |
|------------------|-----|
| Part # 550010-01 | 6" |
| Part # 550010-02 | 8" |
| Part # 550010-03 | 10" |
| Part # 550010-04 | 12" |
| Part # 550010-05 | 14" |
| Part # 550010-06 | 16" |

Notes: • Part #550006 is available only in brushed finish

Aluminum Wood End Showcases

The classic beauty of Stylmark's anodized aluminum extrusions provides a subtle accent to finely crafted woods and laminates. Components are first fabricated and then finished and anodized. This assures that all reflectors, cover tees, glass channels, door hardware, brackets and standards match perfectly. Wood end showcase components are sold fabricated or in stock lengths for field fabrication.

Typical Showcase Components

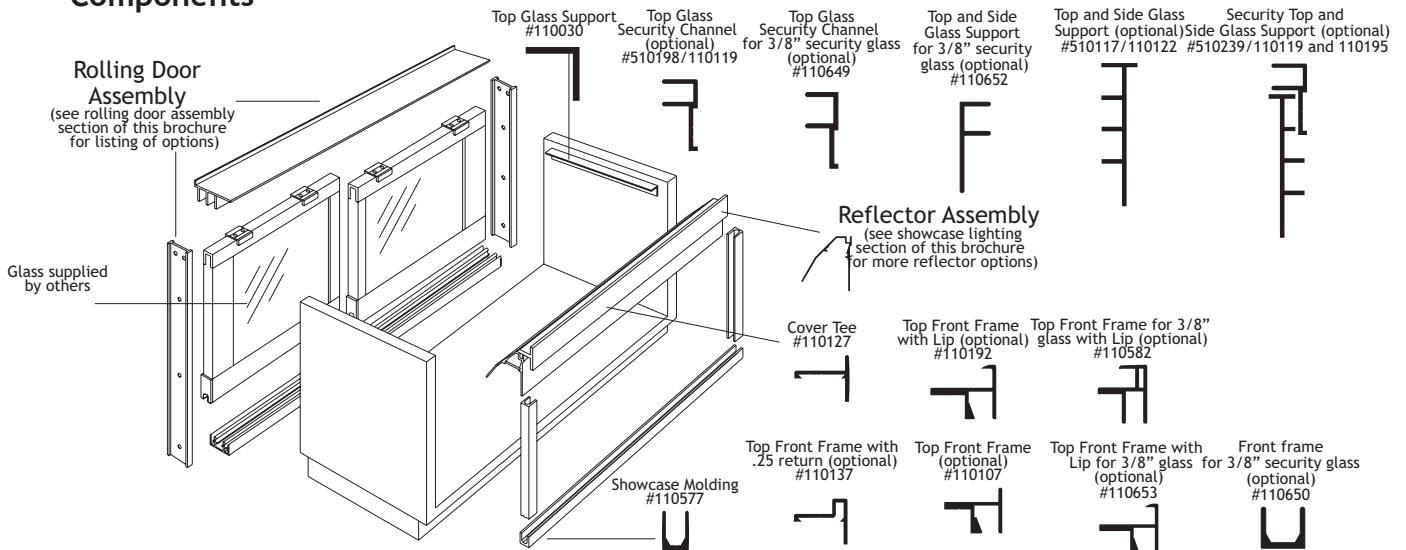

Showcase Components Typical Vertical Section

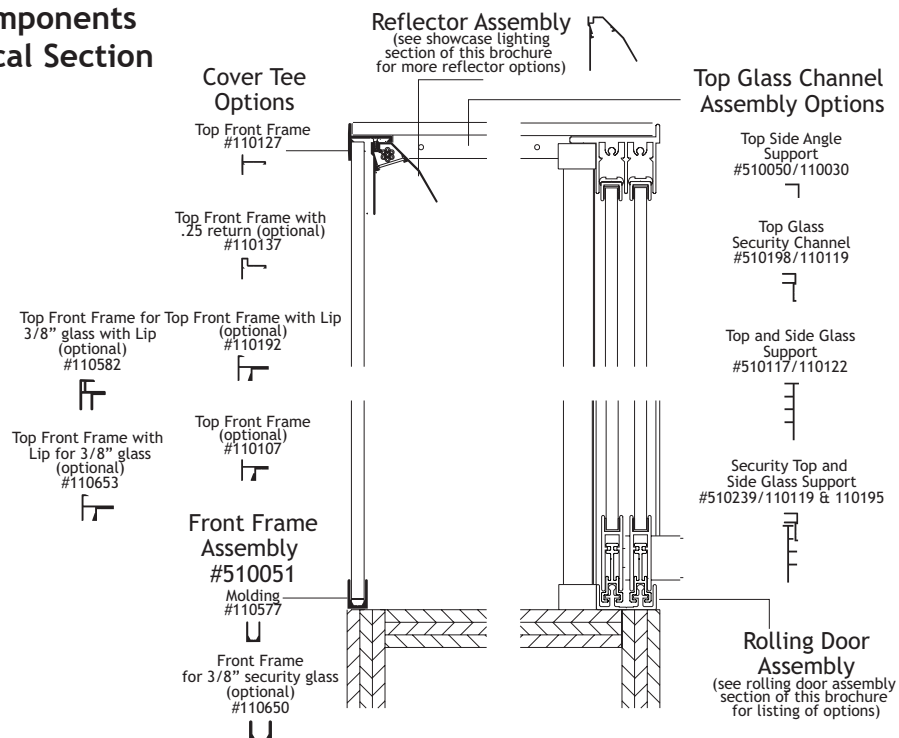

Aluminum Wood End Showcases

Ordering Wood End Showcases

| Reflector Assembly | Rolling Door Assembly | Front Glass Frame Assembly | Top Glass Channel Assembly |
|--------------------|--------------------------|----------------------------|----------------------------|
| See Page 18 | See Rolling Door Catalog | Width x Height | Depth |

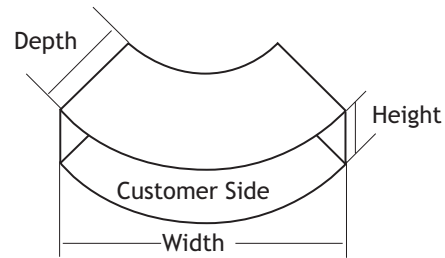
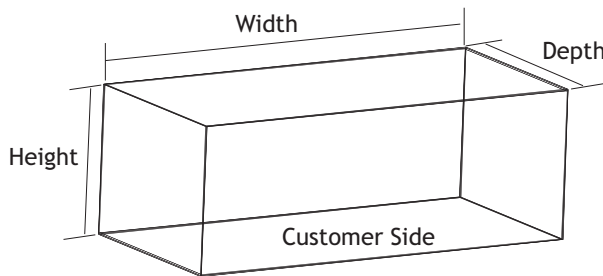

Rectangular or Curved

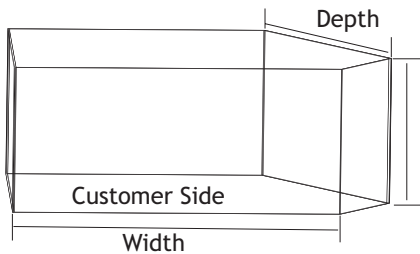

RH Clipped

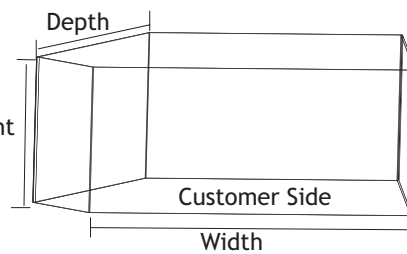

LH Clipped

Right or Left Hand Clipped

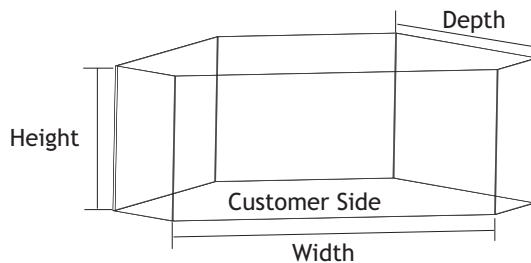

Double Clipped

- Notes:**
- When ordering clipped, curved or custom showcases, please provide shop drawings.
 - Slotted standards and brackets are ordered separately (see page 16).

Aluminum Wood End Showcases

Choose from the options below to customize a showcase to your exact specifications.

Front Frame Options

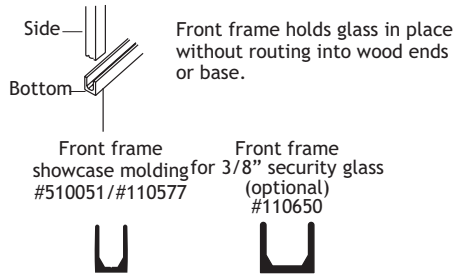

Rolling Door Assemblies

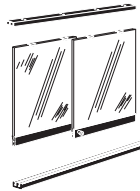

See the rolling door section of this brochure for full configuration details.

Cover Tee Options

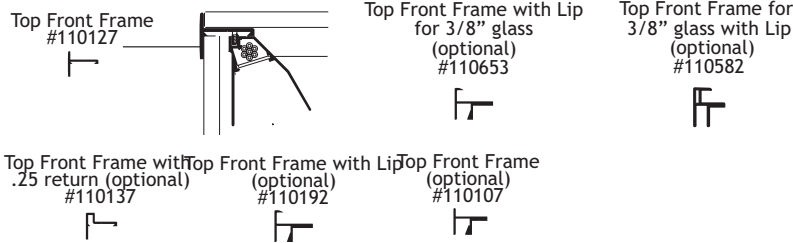

*Some reflectors come with an integrated cover tee - see assemblies below.

Top and Side Glass Channel Assemblies

Top and side glass supports require no routing of wood ends or base to install. Glass supports give you the option to provide security.

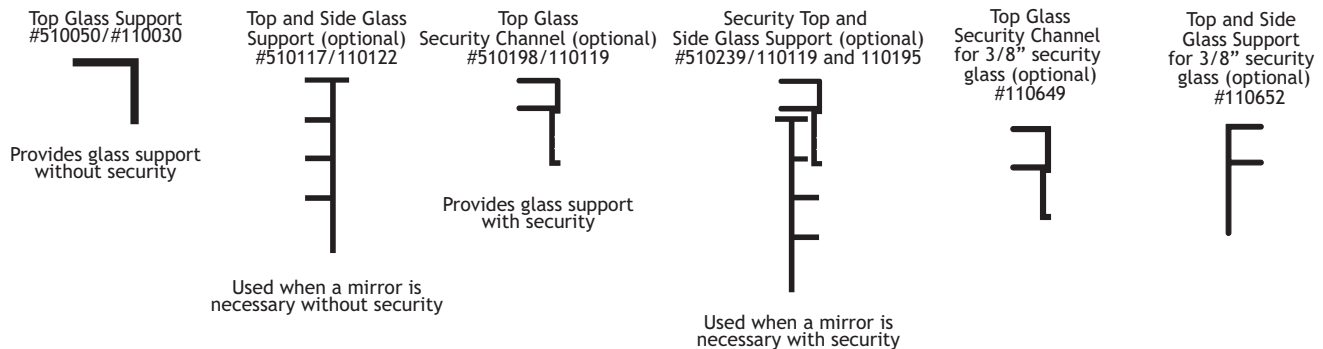

Notes: *Indicates integrated cover tee reflectors.

Aluminum Wood End Showcases

Hardware and Accessories

Part #110030
1/2" Angle

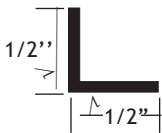

Part #110106
Mullion

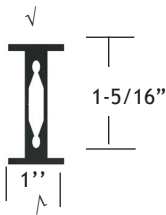

Part #110107
Front Frame

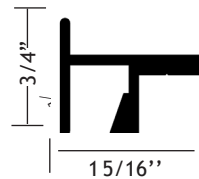

Part #110119
Security Channel

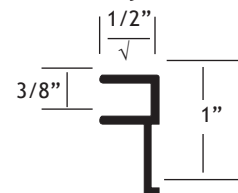

Part #110122
Top and Side
Glass Support

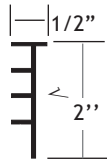

Part #110127
Top Front Frame

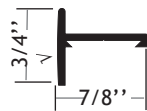

Part #110137
Cover T with
.25 Return

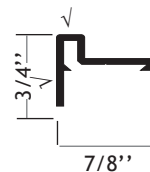

Part #110192
Front Frame
with Lip
for 1/4" glass



Part #110195
Security Top and
Side Glass Support

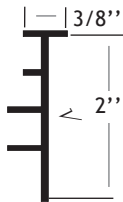

Part #110523
Backframe Header
without Top Glass

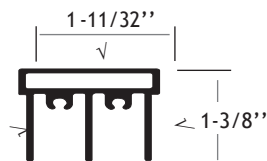

Part #110577
Showcase Molding
without holes
(with holes #410099)

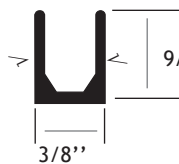

Part #110582
Showcase Rail

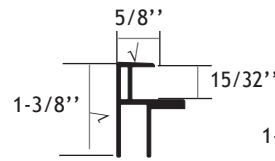

Part #110640
Backframe Header
without Top Glass
for 1/2" glass

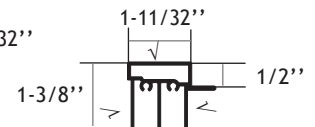

Part #110650
Front Frame for 3/8"
Security Glass

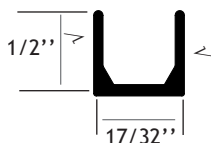

Part #110653
Front Frame
with Lip
for 3/8" glass

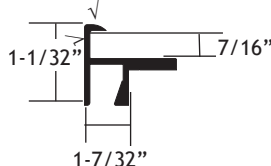

Part #119029
Vinyl Bumper



Part #232006
6" Steel Bracket

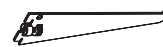

Part #511178
Top Guide Assembly

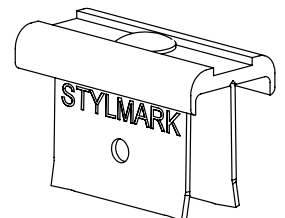

Notes: • With the exception of reflector assemblies, wood end showcase components can be ordered in stock lengths for customer fabrication.

√ = finished surface

Aluminum Wood End Showcases

Hardware and Accessories

Part #232023
Slotted Steel Standard,
36''
(96'' #232028)



Part #450010
Slotted Standard

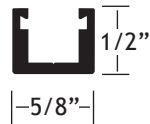

Part #450020
Heavy Duty
Slotted Standard



Part #450021
Rear Support for
#450020



Part #450022
Rear Support
for #450010



Part #510089
Mounting Bracket
Assembly for
110107/110192

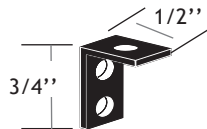

Part #550007
Foot and Cap
Assembly for
Aluminum Standard

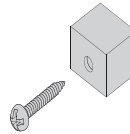

Part #550008
Chrome Bottom Cap
Assembly for Steel
Standard

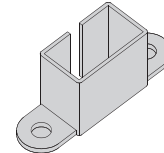

Part #550009
Chrome Top Cap
Assembly for
Steel Standard

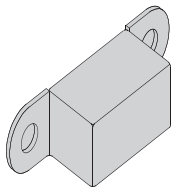

Part #550011
Shelf End Clip
for 550010

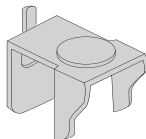

Part #550012
Shelf Center
Clip for 550010

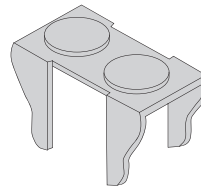

Part #550013
Glass End Clip
for 550006

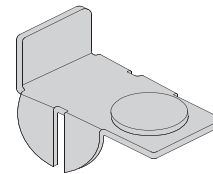

Part #550014
Glass Center Clip
for 550006

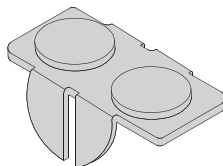

Part #550006
Aluminum Shelf Blade Bracket
with and without lip
Available in
6, 8, 10, 12, 14, 16''
(See page 11)

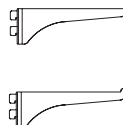



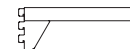











Part #550010
Aluminum Tubular
Shelf Bracket
Available in
6, 8, 10, 12, 14, 16''
(See page 11)



Light Reflectors

Stylmark’s showcase lighting products are created with design flexibility in mind. Our product line accommodates a variety of mounting configurations and lighting options from traditional light sources to new marketplace trends, like LED. Reflector profiles are streamlined to maximize viewable display space. All of our showcase lighting is component recognized by UL or ETL to US and Canadian standards.

| ORDERING SHOWCASE REFLECTORS | |
|------------------------------|---|
| CHOOSE A PROFILE |  680100  680400  680600  683900 <small>(standard assembly)</small>  683900 <small>(screw port assembly)</small>  684200  685000 |
| CHOOSE A COVER TEE |  110107*  110127  110137  110192*  110582  110653*  110800* <small>(FOR 680100 & 680200 REFLECTORS ONLY) (*FOR 683900 REFLECTORS ONLY)</small> |
| CHOOSE A MOUNTING SYSTEM | FLEX CONDUIT WITH MOUNT BRACKET OR RIGID EXPOSED DOWNTUBE WITH REFLECTOR END CAPS |
| DIMENSIONS | LENGTH OF REFLECTOR |
| REFLECTOR LOCATION | FRONT, REAR OR FRONT AND REAR |

- Notes:**
- Grounded receptacles, part #230028, are sold separately (see page 32).
 - LED reflectors ordered separately from showcase.

Light Reflector Assemblies

Reflector Profiles

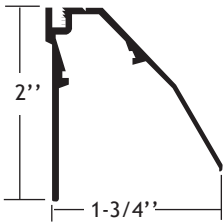

680100 series

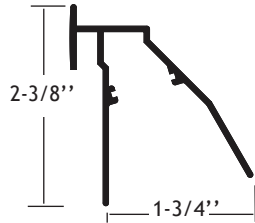

680400 series

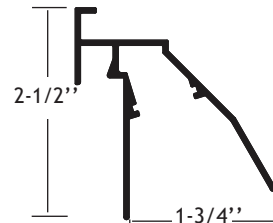

680600 series

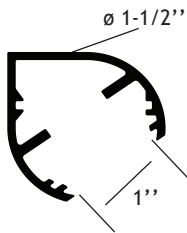

683900 series
(standard assembly)

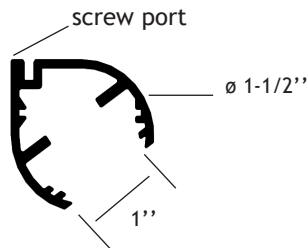

683900 series
(screw port assembly)

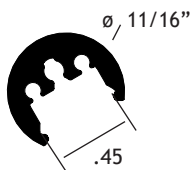

684200 series

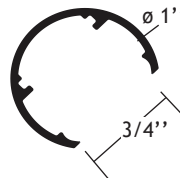

685000 series

Light Reflectors

Light Source Specifications

| Lamp Type | Lamp Destination | Rated Watts | Nominal Lamp Length | Color Temp K | Color Rendering Index | Rated Lumens | Rated Lamp Life |
|-----------|------------------------|-------------|---------------------|--|-----------------------|--------------|-----------------|
| LED | Premium (24Vdc) MIG 24 | 9.0W/ft | 12" / 6" | ANSI: 3500K Bin 4000K Bin 5000K Bin | 80+ | 700 lm/ft | 50,000+ Hrs |
| | Deluxe (24Vdc) MIG 24 | 4.6W/ft | 12" / 6" | | 80+ | 350 lm/ft | 50,000+ Hrs |
| | Premium (24Vdc) NIGEL | 6.7W/ft | 20" / 12" / 4" | ANSI: 3500K Bin 4000K Bin 5000K Bin | 80+ | 700 lm/ft | 50,000+ Hrs |
| | Deluxe (24Vdc) NIGEL | 3.8W/ft | 20" / 12" / 4" | | 80+ | 500 lm/ft | 50,000+ Hrs |

Light Reflectors

Reflector Assemblies

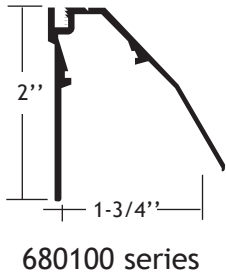

#510061
Endcap Assembly for
680100 Series Assemblies

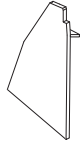

Front Reflector/Cover Tee Options

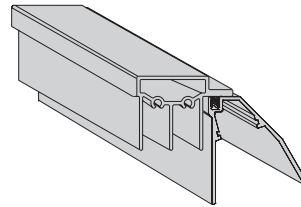
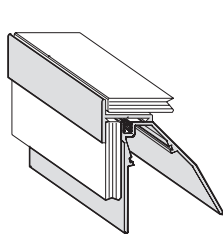

Mounting Options for Aluminum Wood End Showcases

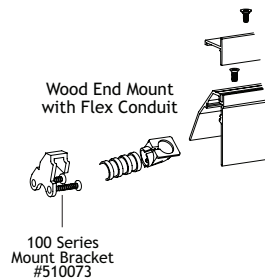
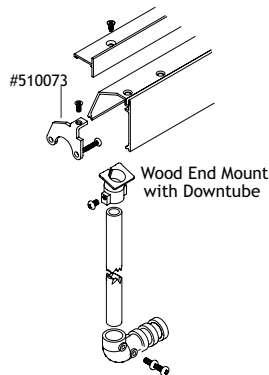

Mounting Options for Aluminum Glass End Showcases

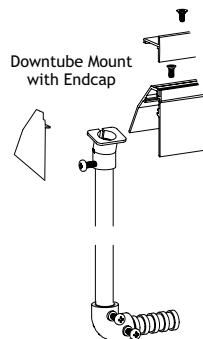

√ = finished surface
Drawings are not to scale

Light Reflectors

Reflector Assemblies

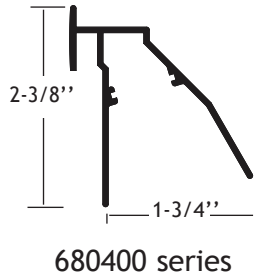

Mounting Options for Aluminum Glass End Showcases

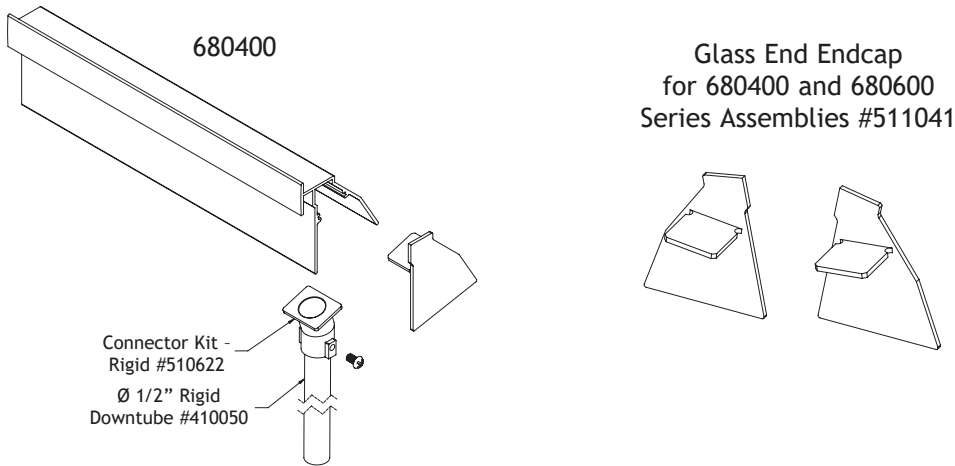

Mounting Options for Wood End Showcases

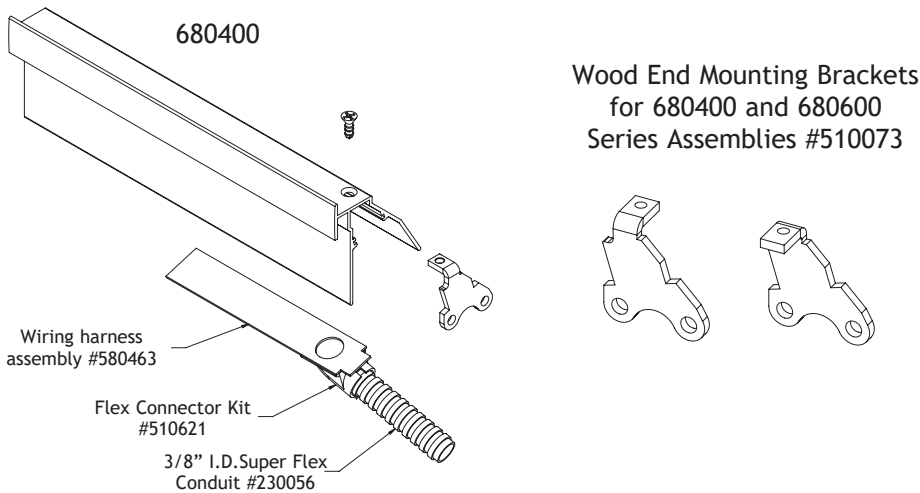

√ = finished surface
Drawings are not to scale

Light Reflectors

Reflector Assemblies

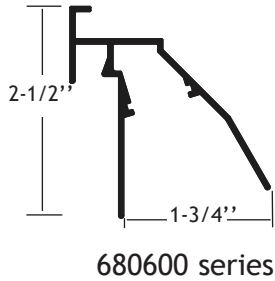

Mounting Options for Aluminum Glass End Showcases

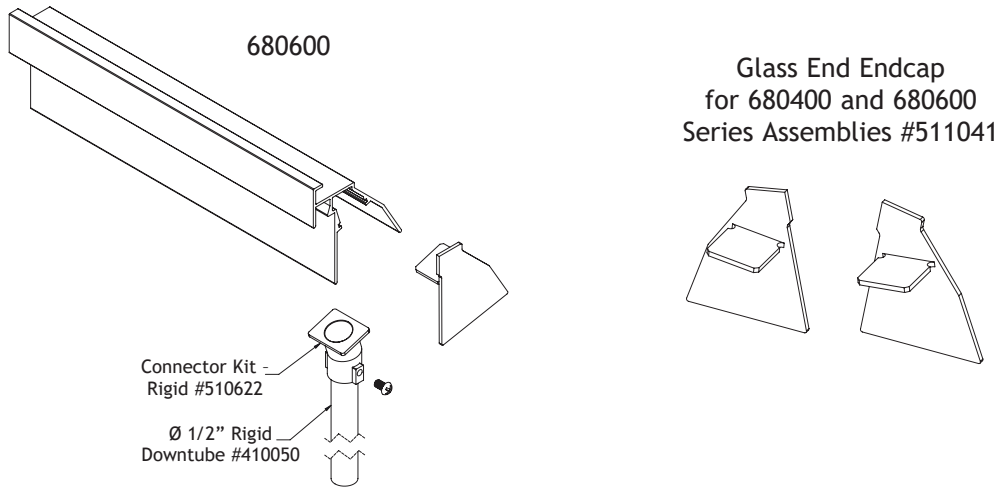

Mounting Options for Wood End Showcases

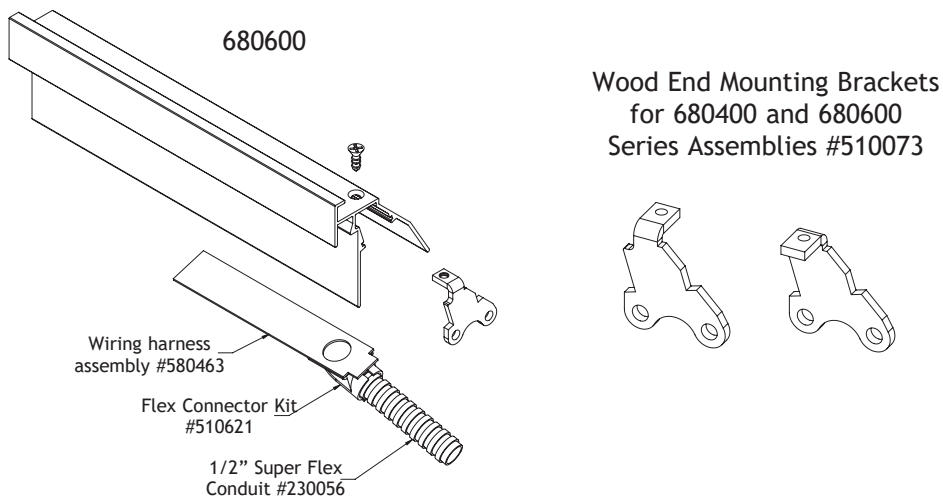

√ = finished surface
 Drawings are not to scale

Light Reflectors

Reflector Assemblies

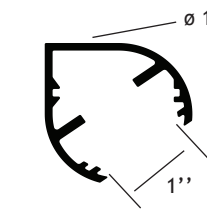

683900 series
(standard assembly)

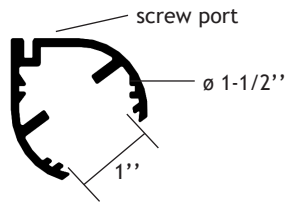

683900 series
(screw port assembly)

#481057 LH and 481056 RH
Endcaps for 683900 Series
Assemblies



Mounting Options for Aluminum Wood End Showcases

1 1/2" - #380270
1 3/8" - #480991

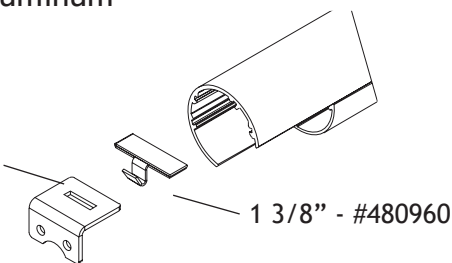

Rotating Downtube Option (683700 Series Only)

(Extrusion #180144 and components are available but not as an assembly)

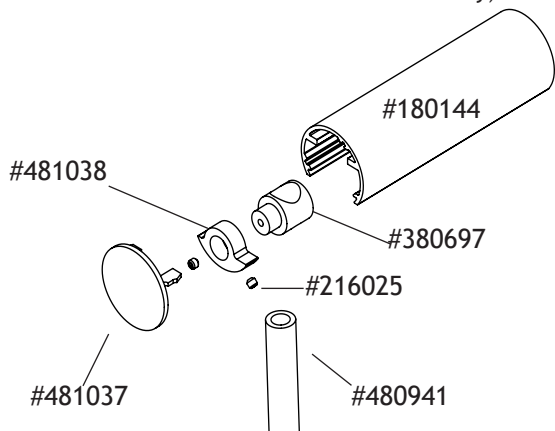

Mounting Options for Aluminum Glass End Showcases

1 1/2" - #480951
1 3/8" - #481041

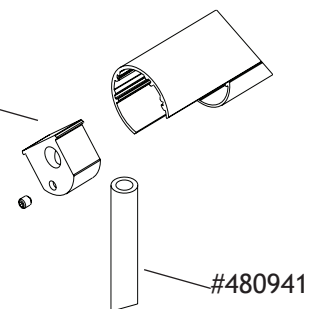

Light Reflectors

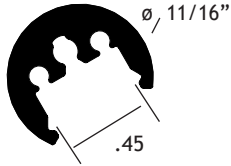

684200 series

| LED Board | Model # | 3500K | 4000K | 5000K |
|-------------|---------|-------|-------|-------|
| Deluxe 4" | 242055 | | | |
| Deluxe 12" | 242056 | | | |
| Deluxe 20" | 242057 | | | |
| Premium 4" | 242058 | -200 | -300 | -400 |
| Premium 12" | 242059 | | | |
| Premium 20" | 242060 | | | |

Mounting Options for Rotating Downtube

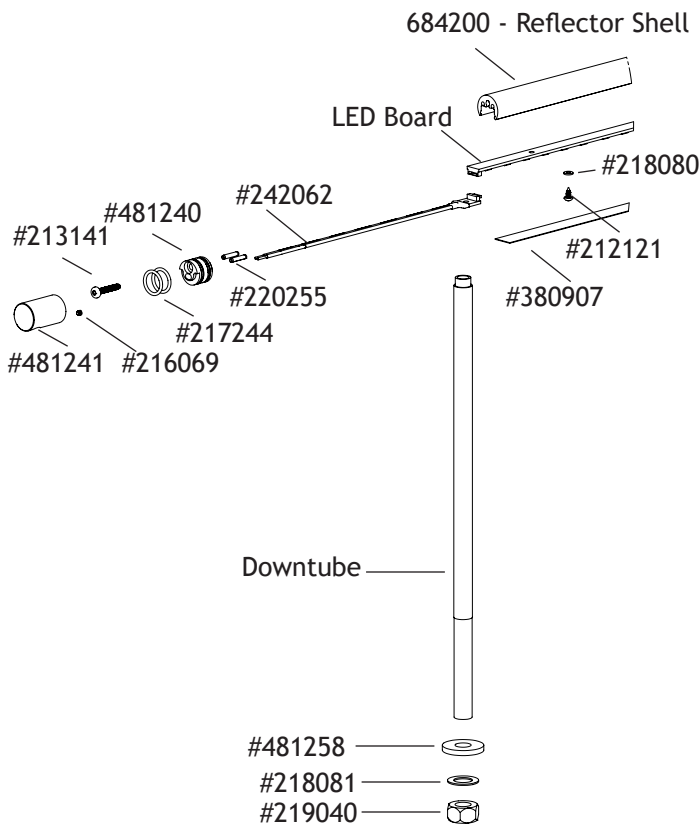

Mounting Options for Wood End Showcase

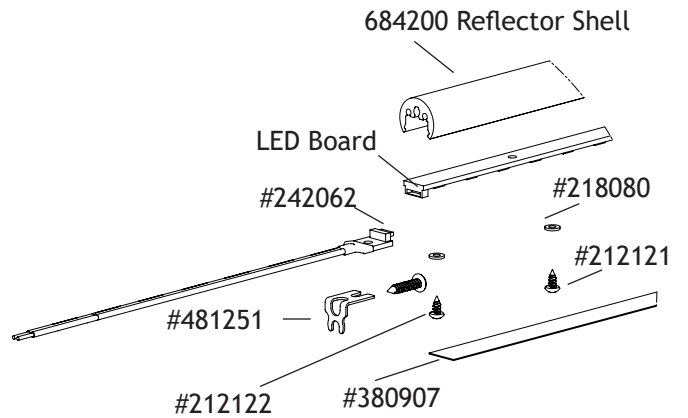

√ = finished surface
 Drawings are not to scale

Light Reflectors

Reflector Assemblies (LED only)

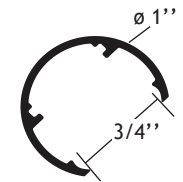

685000 series

#480989
Endcap for 685000 Series
Assemblies

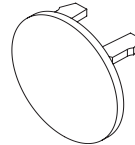

Rotating Downtube Option

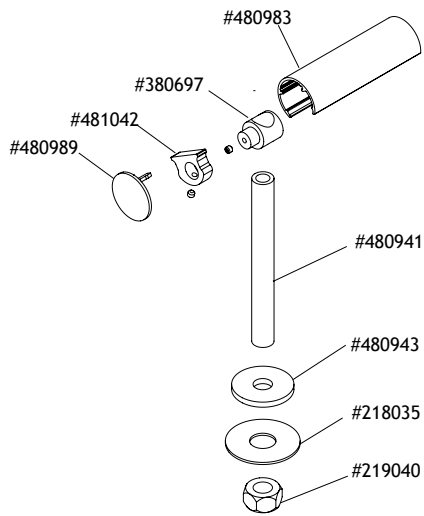

Mounting Options for Aluminum Wood End Showcases

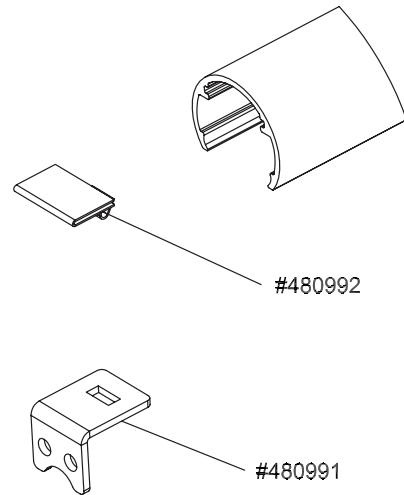

Mounting Options for Aluminum Glass End Showcases

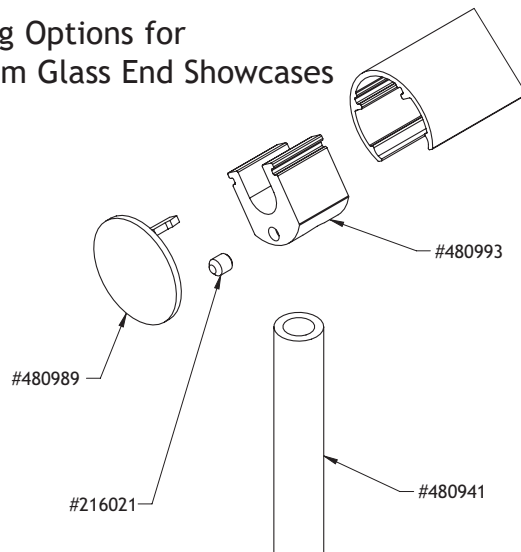

Rotating Mounting Bracket Option

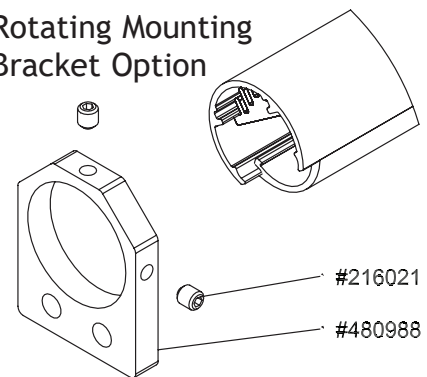

√ = finished surface
Drawings are not to scale

Reflector Extrusion Profiles

These profiles can be ordered as stock length extrusions.

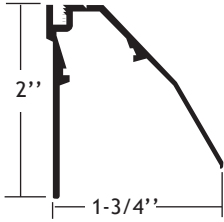

Extrusion #110135

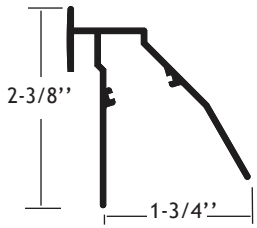

Extrusion #180139

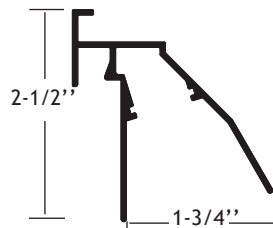

Extrusion #110719

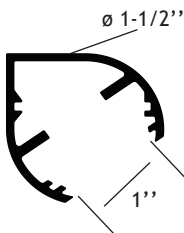

Extrusion #180147

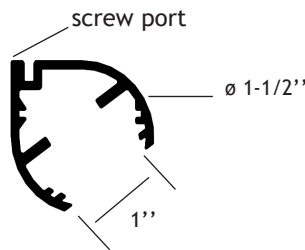

Extrusion #180150

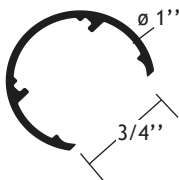

Extrusion #180133

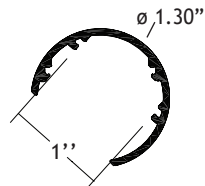

Extrusion #180144

Light Reflectors

Installation of Downtube
for 680100 Series
680400 Series, 680600 Series,
683900 Series, 684200 Series,
685000 Series.

Installation of Downtube

| Series | Fixed "A" |
|----------------------------|-----------|
| 680100 680400 680600 | 1-1/2" |

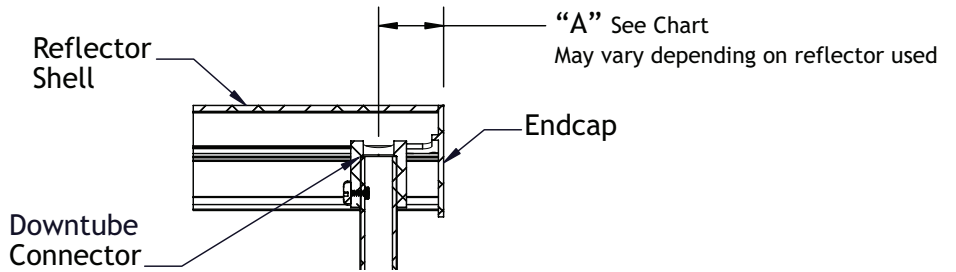

Installation of Downtube

| Series | Adj. Angle "A" | Fixed "A" |
|--------|----------------|-----------|
| 683900 | N/A | 7/8" |
| 685000 | 11/16" | 25/32" |

Fixed

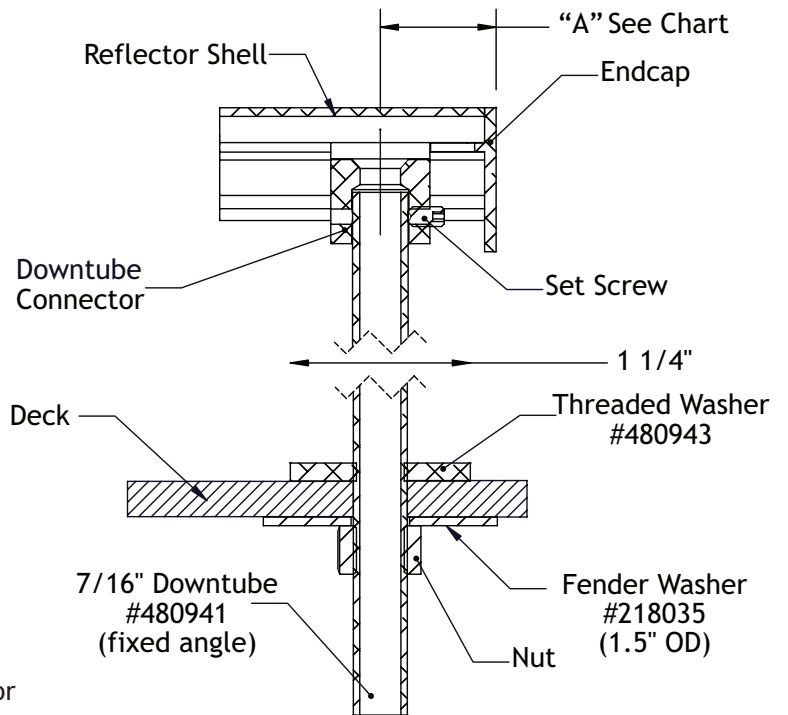

Adj. Angle

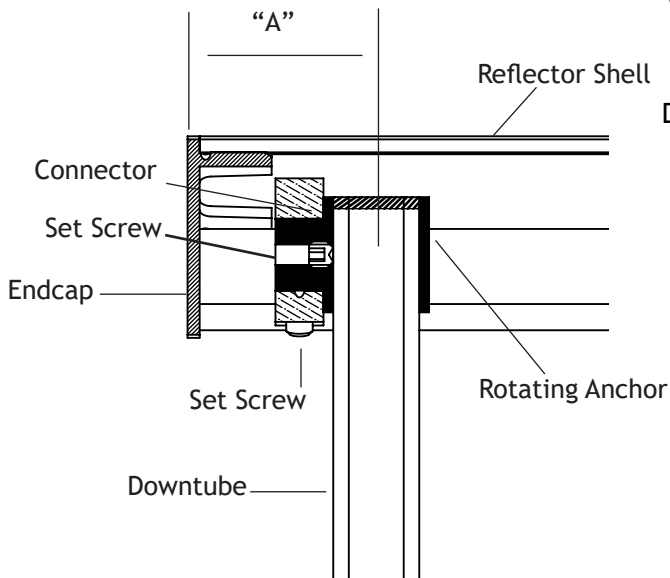

Light Reflectors

Model 684200

Installation of Downtube

| Series | Adj. Angle "A" | Fixed "A" |
|----------------------------|----------------|-----------|
| 684200 with 1" Washer | 1/4" | 1/2" |
| 684200 with 3/4" Washer | 1/4" | 3/8" |

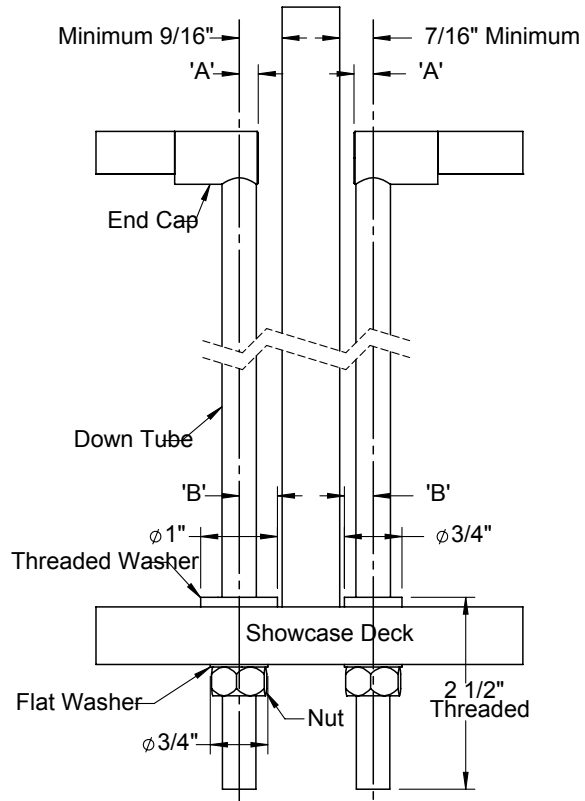

Lighting Accessories

Hardware and Accessories

Part #110099
Reflector Strip

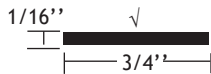

Part #110071
Showcase Channel

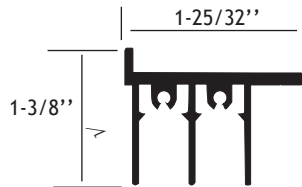

Part #110102
Top Rear
Showcase Channel

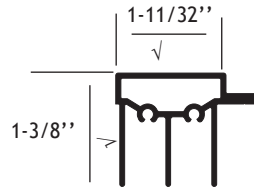

Part #110107
Front Frame

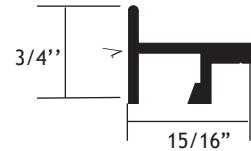

Part #110127
Top Front Frame

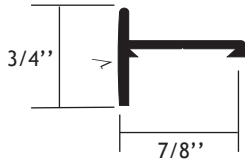

Part #110137
Cover Tee
with .25 Return

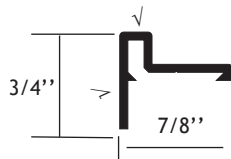

Part #110192
Front Frame with Lip

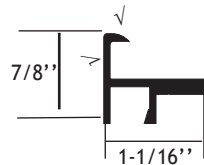

***Part # 110495**
Connector, Straight

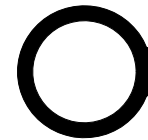

Part #218035
Fender Washer
1-1/2" O.D.

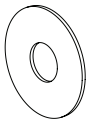

Part #219039
Nut

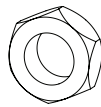

***Part #230056**
3/8" I.D. Super Flex
Conduit, 250 ft.



***#230056-01** 3/8" I.D.
Super Flex Conduit, 7 ft.

***#230056-02** 3/8" I.D.
Super Flex Conduit, 4 ft.

***#230056-04** 3/8" I.D.
Super Flex Conduit, per ft.

***Part #310124**
90° Connector

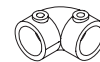

Part #380270
LED 1-1/2" Reflector
Mount Bracket



Part #380491
LED 1" Reflector
Mount Bracket

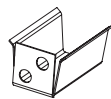

Part #380583
Connector

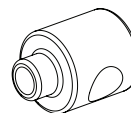

Part #410050
1/2" Downtube
3/8" I.D.

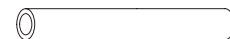

Notes: * Not UL Listed or Recognized Component

√ = finished surface

Lighting Accessories

Hardware and Accessories

Part #480753
3/8" Threaded Washer
1" O.D.

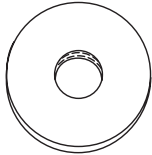

Part #480756
Support Puck

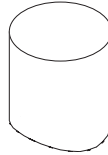

Part #480757
3/8" Downtube
9/32" I.D.



Part #480767
Rigid Connector
3/8" Downtube

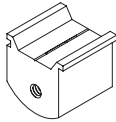

Part #480941
7/16" Downtube
9/32" I.D.



Part #480942
Downtube Threaded
9/32" I.D.



Part #480943
7/16" Threaded Washer
1-1/4" O.D.

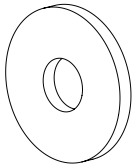

Part #510073
Mount Bracket
Assembly

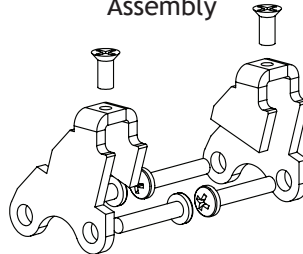

Part #510378
Downtube Flange

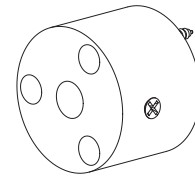

Part #510621
Flex Connector
3/8" I.D. Conduit



Part #510622
Rigid Connector
1/2" Downtube

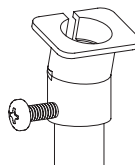

Lighting Accessories

LED Power Supplies and Drivers

LED LOW VOLTAGE POWER CABLES (Connects power supply to LED reflector)

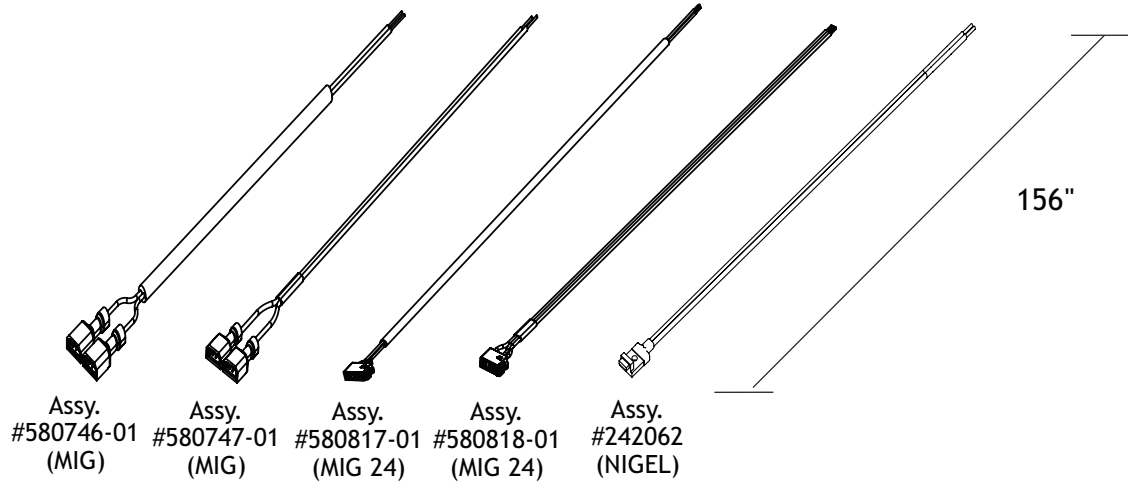

Power Supplies

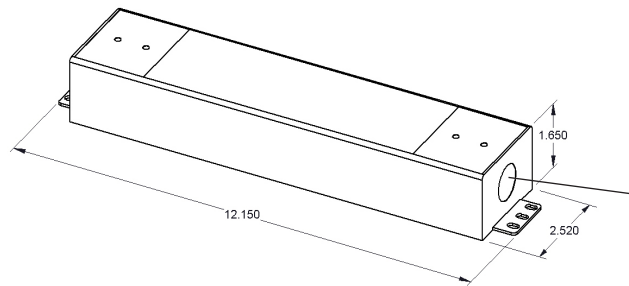

Part # 230982
(24Vdc constant voltage output)
100 Watt Power Supply

For 7/8" conduit connector

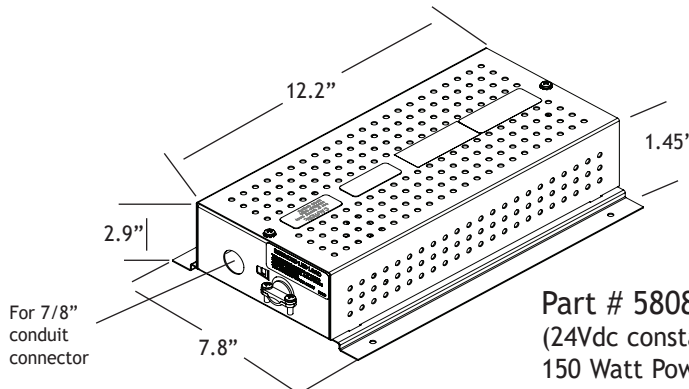

Part # 580829
(24Vdc constant voltage output)
150 Watt Power Supply

For 7/8" conduit connector

Lighting Accessories

Single Ballast Box and Components

#510599
Single Ballast Box Kit

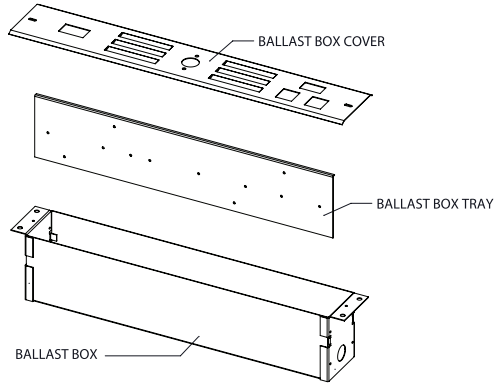

#510101
Single Ballast Box

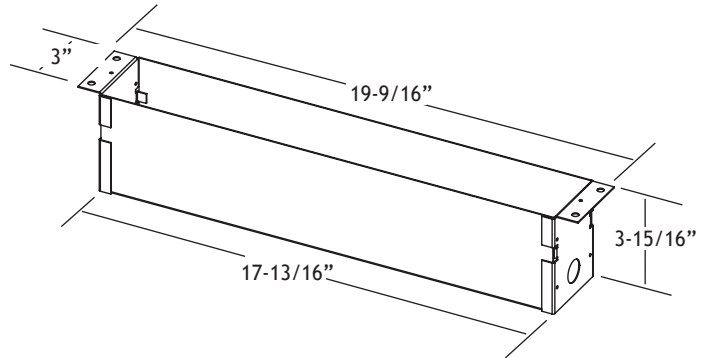

#510598
Ballast Box
Accessory Kit

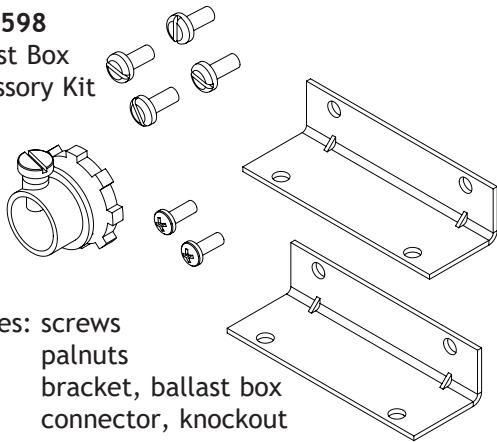

Includes: screws
palnuts
bracket, ballast box
connector, knockout

Ballast Box Cover Plate

#310079 - Painted Black Steel
#310577 - Anodized Aluminum (See Stylmark
anodized color offerings)

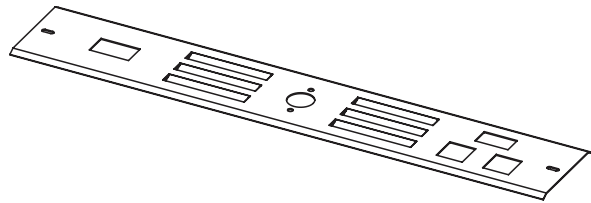

#230028
Grounded Receptacle

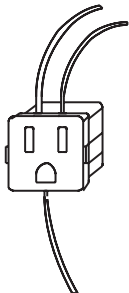

#230085
Rocker Switch

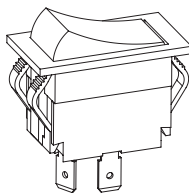

#310080
Single Ballast Box Insert Tray for Single Ballast Box

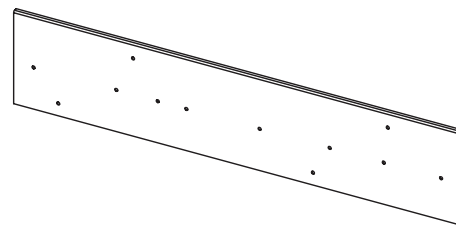

Notes: • #510600 - Single ballast box kit and accessories includes part numbers #510599 and #510598

Lighting Accessories

Double Ballast Box and Components

#510625
Double Ballast
Box Kit

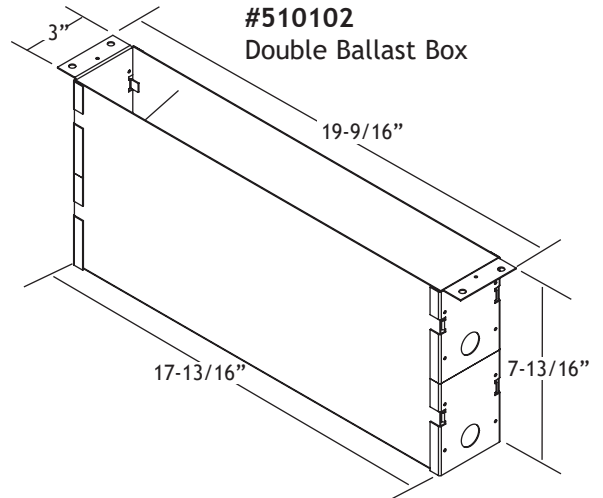
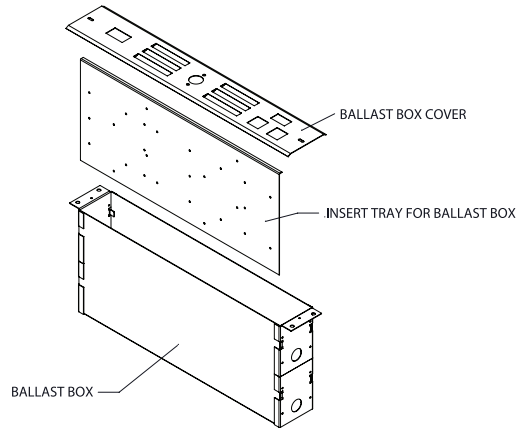

#510598
Ballast Box
Accessory Kit

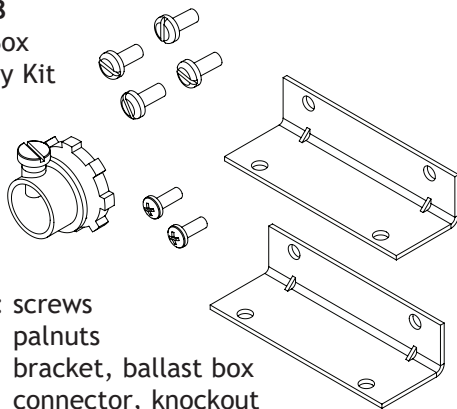

Includes: screws
palnuts
bracket, ballast box
connector, knockout

Ballast Box Cover Plate

#310079 - Painted Black Steel
#310577 - Anodized Aluminum (See Stylmark
anodized color offerings)

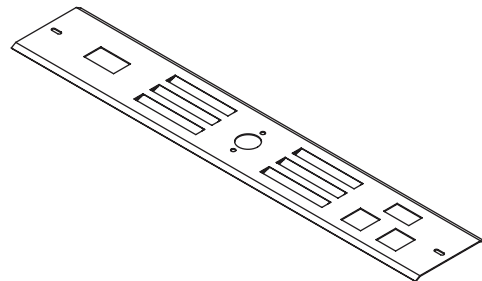

#230028
Grounded Receptacle

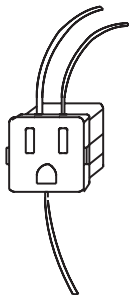

#230085
Rocker Switch

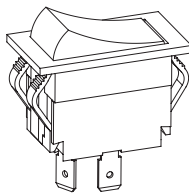

#310085
Ballast Box Insert Tray for Double Ballast Box

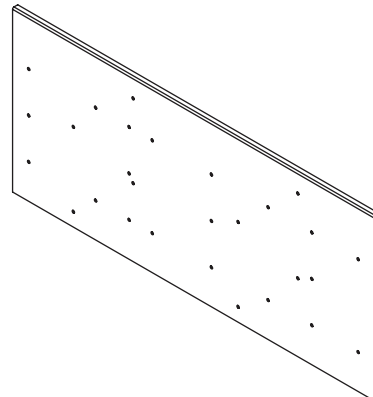

Notes:

- #510626 - Double ballast box kit and accessories includes part numbers #510625 and #510598